

Flying and Judging F3A

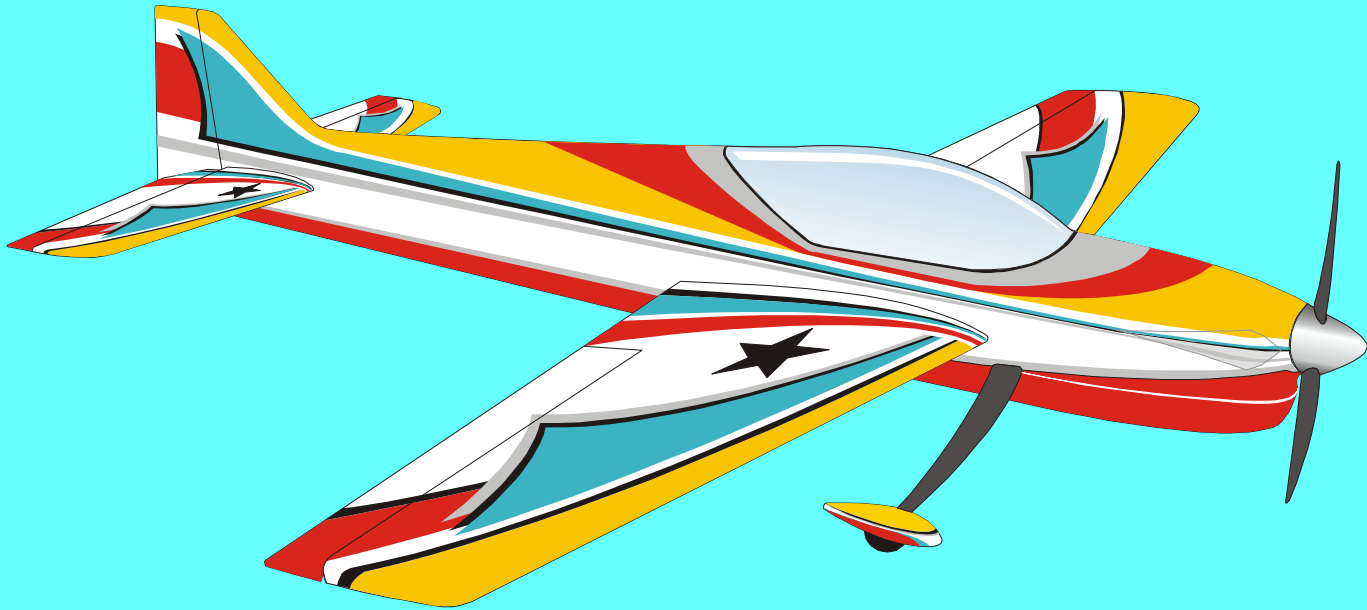

SCHEMATIC MANOEUVRE ILLUSTRATIONS
SCHEDULE F-25

FINAL SCHEDULE F-25 (2023-2025)

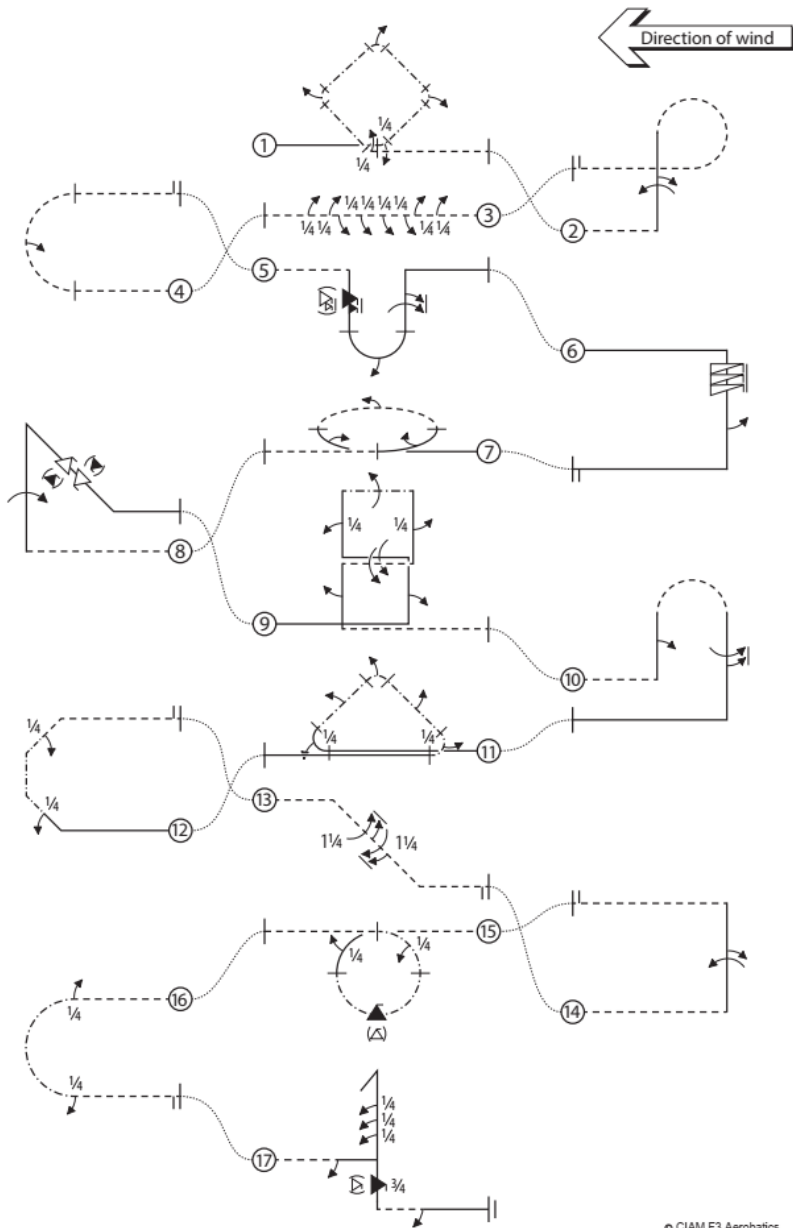

FINAL SCHEDULE F-25 (2023-2025)

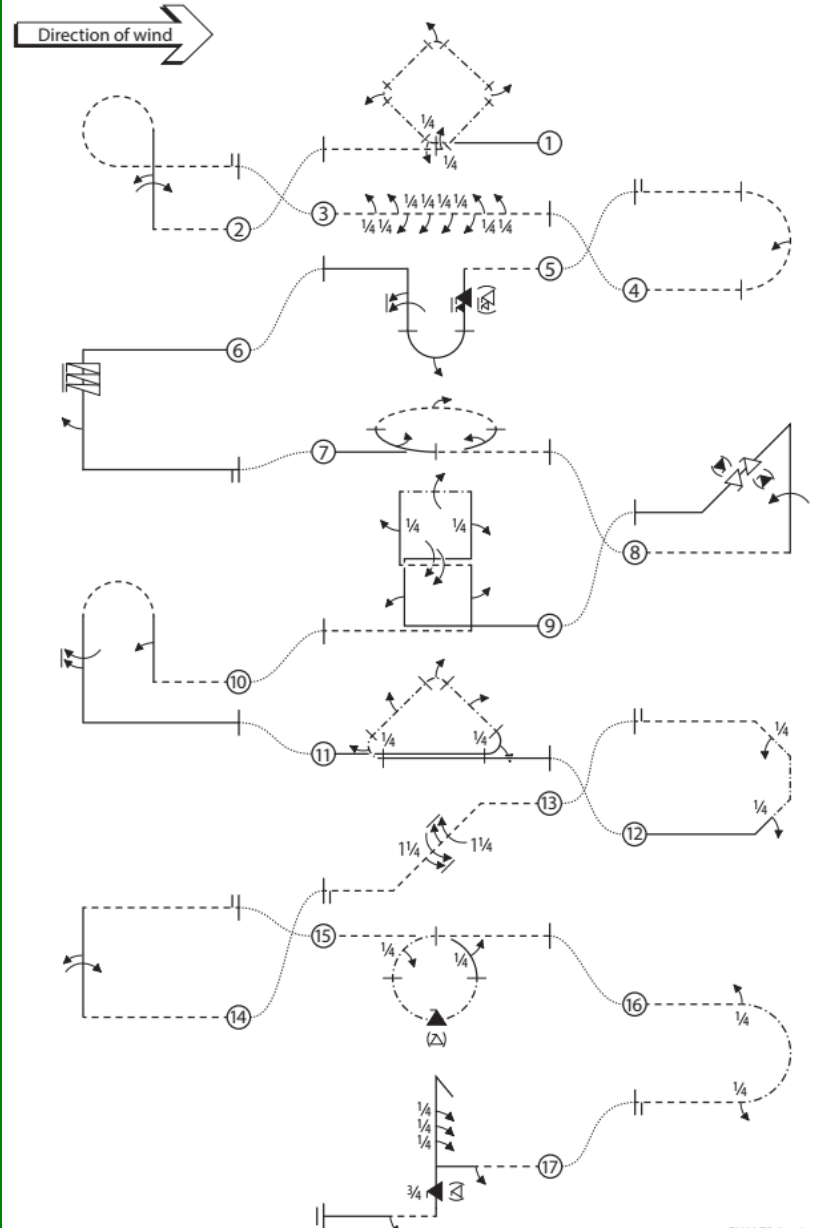



Explanations:

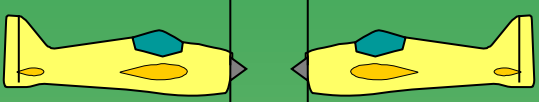

Aircraft upright

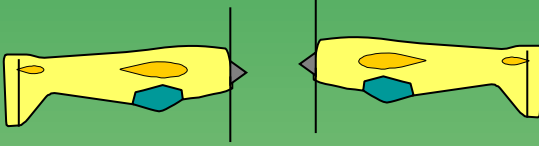

Aircraft inverted

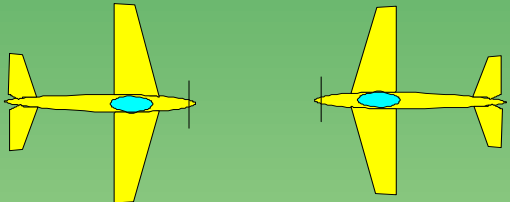

Aircraft in Knife-Edge View from Top

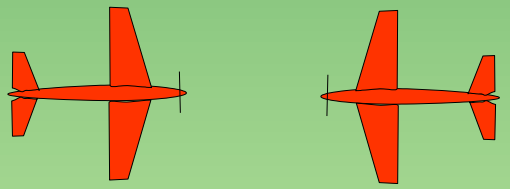

Aircraft in Knife-Edge View from Below



part roll



half roll



roll



pos. spin



neg. spin



pos.



neg.

snap rolls



reference points



Take-off procedure (not judged, not scored)

 wind

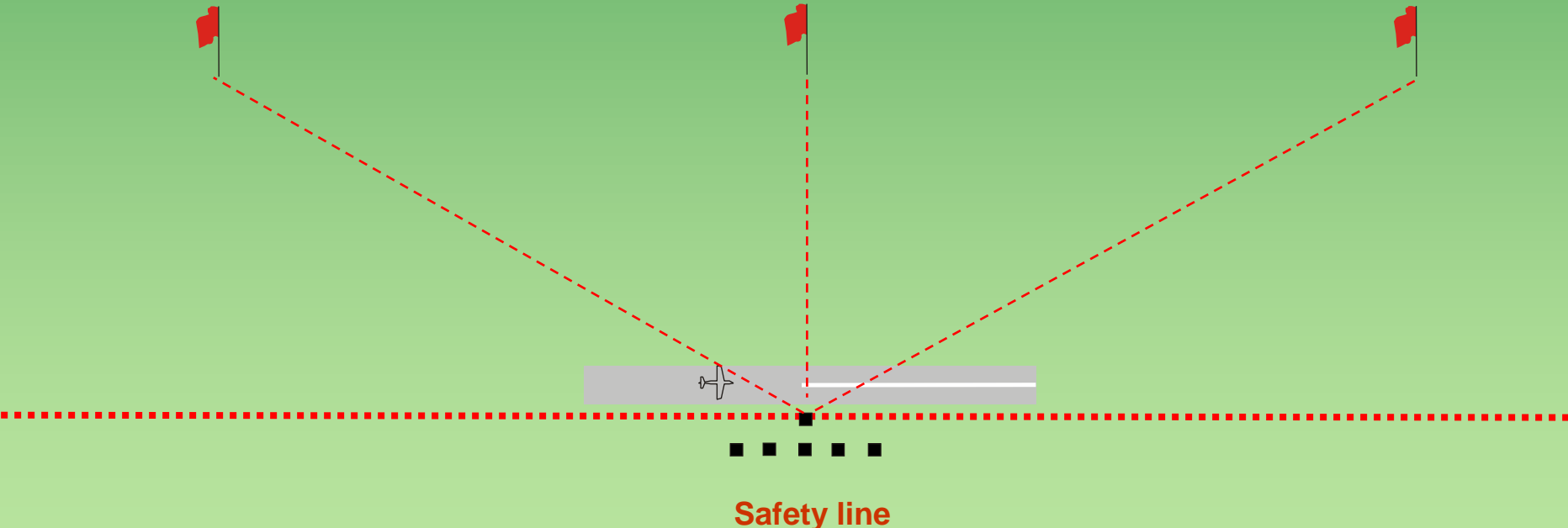



F-25.01 Square loop on Corner with quarter roll integrated, half roll integrated, half roll integrated, half roll integrated, quarter roll integrated

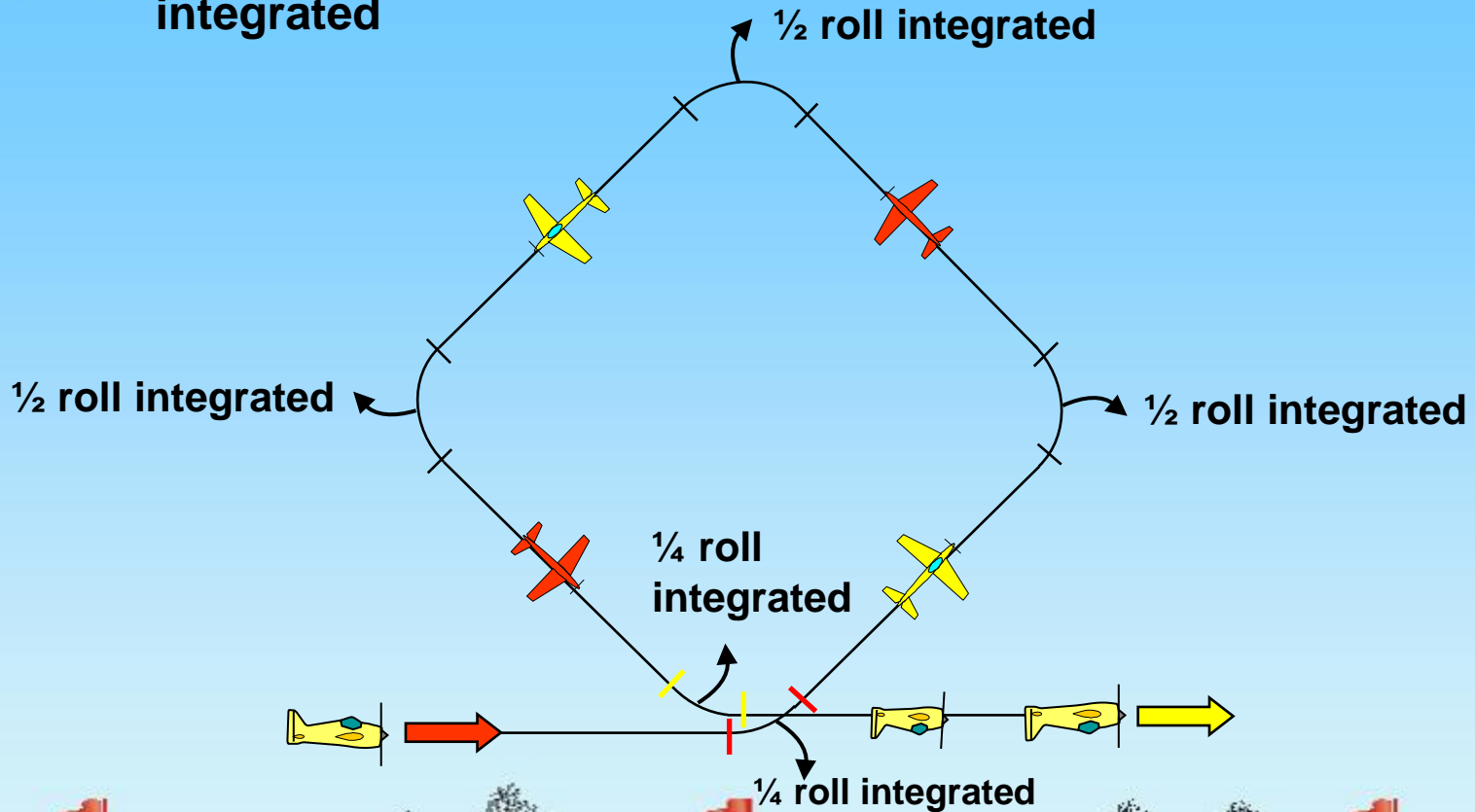

From upright, pull through a one eighth loop with quarter roll integrated into a forty-five degree knife-edge upline, perform a quarter knife-edge loop with half roll integrated into a forty five degree knife-edge upline, perform a quarter knife-edge loop with half roll integrated into a forty five degree knife-edge downline, perform a quarter knife-edge loop with half roll integrated into a forty five degree knife-edge downline, perform a one eighth knife-edge loop with quarter roll integrated, exit inverted.



F-25.01 Square loop on Corner with quarter roll integrated, half roll integrated, half roll integrated, quarter roll integrated

Part rolls integrated on circular flightpath of the part loops.

During Knife Edge the wing must be in the vertical plane.

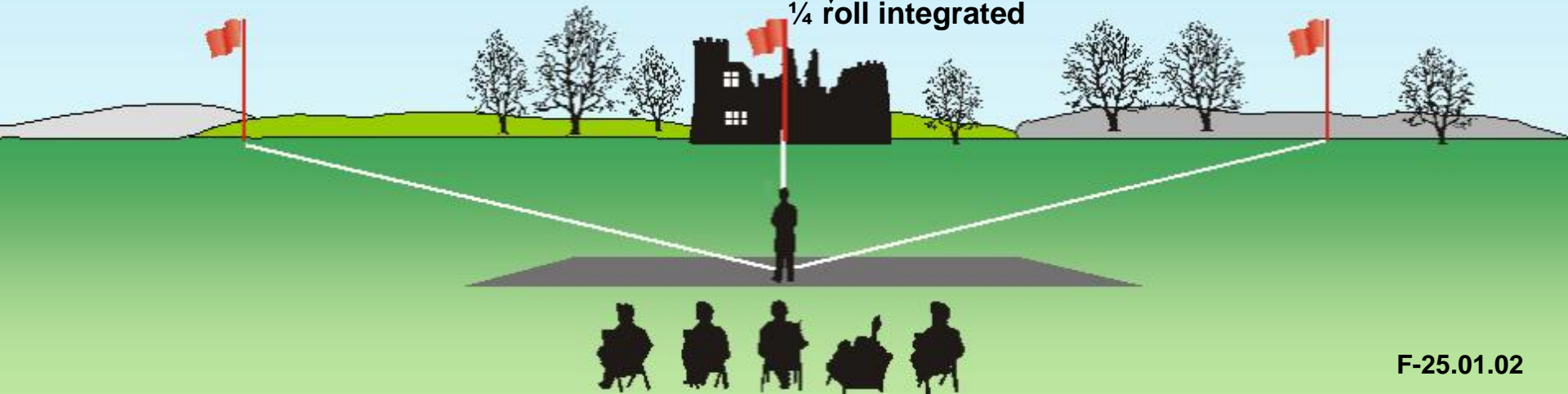
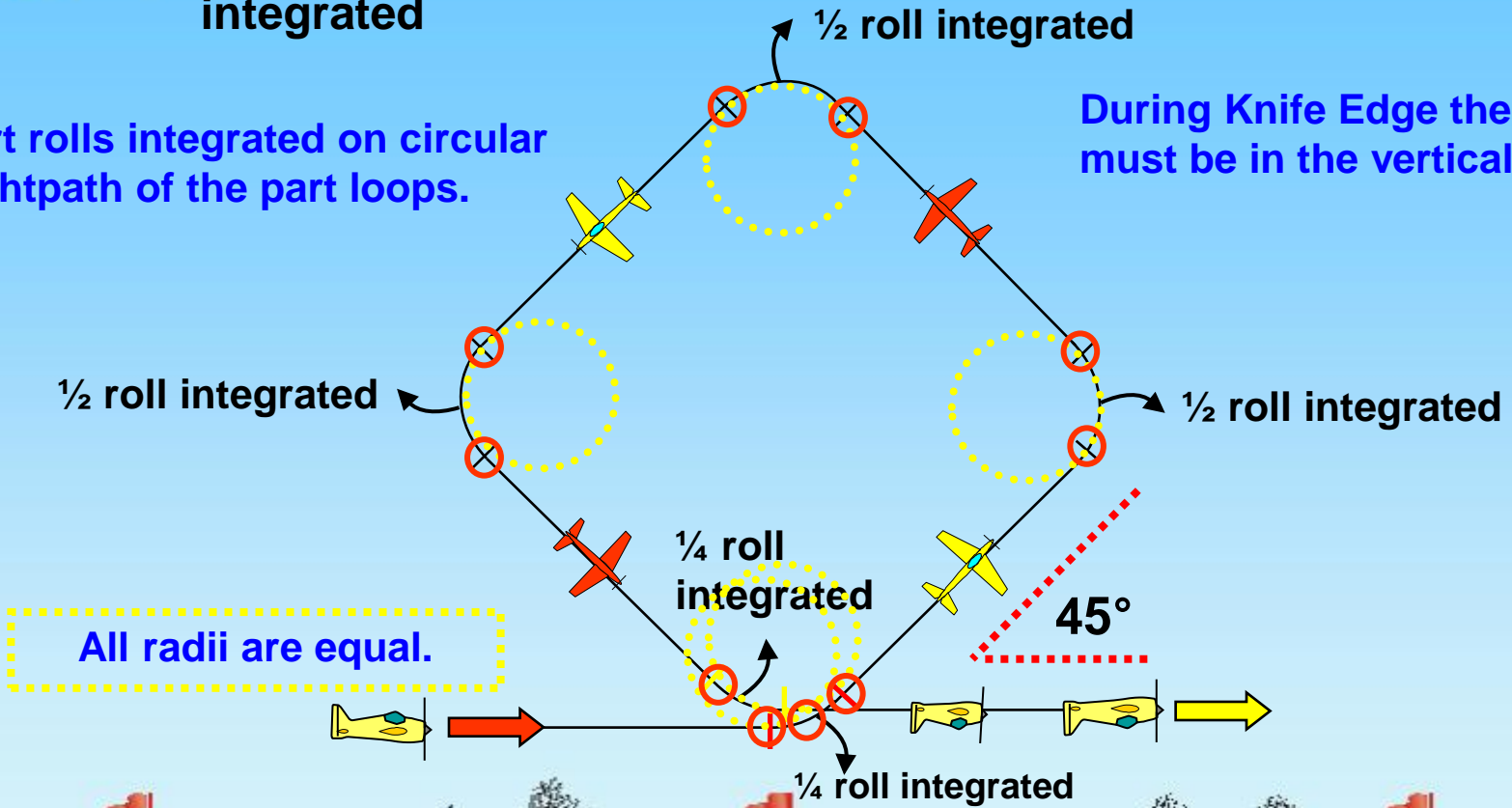



F-25.02 Figure Nine with roll, half roll in opposite directions

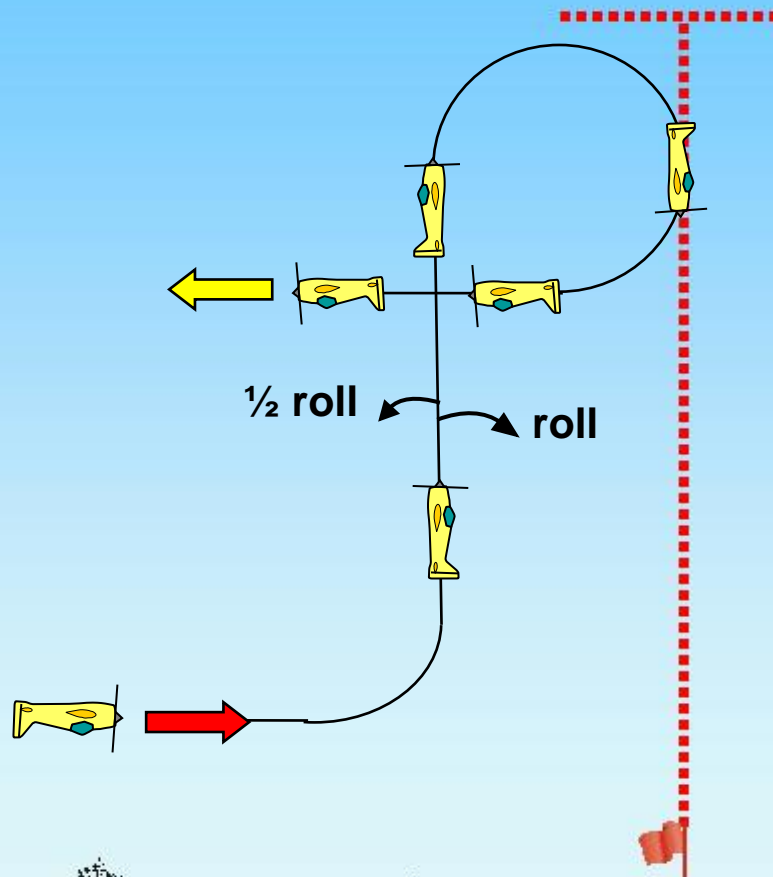

From inverted, push through a quarter loop into a vertical upline, perform consecutively a roll and a half roll in opposite directions, push through a three quarter loop, exit inverted.

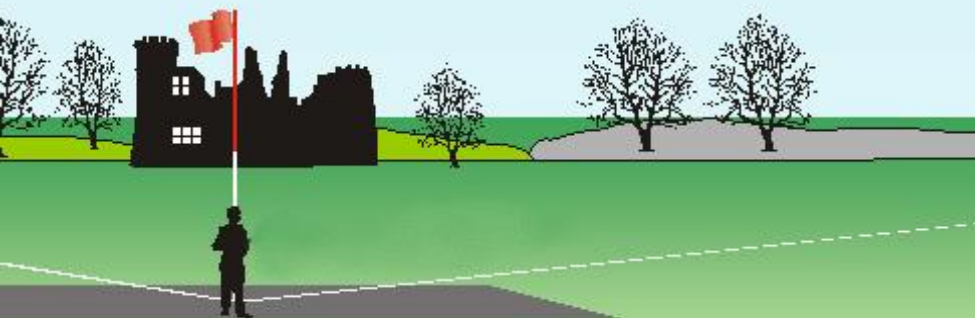



F-25.02 Figure Nine with roll, half roll in opposite directions

Roll and $\frac{1}{2}$ roll centered on middle of the line.

Between rolls and part rolls in opposite directions there must be no line.

All radii are equal.

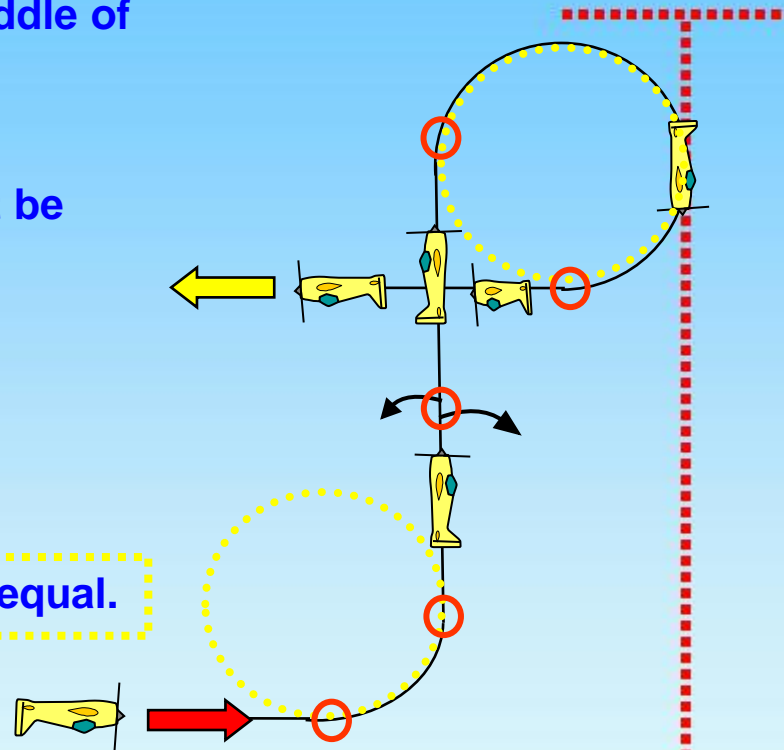



F-25.03 Roll Combination with consecutive two quarter rolls, four consecutive quarter rolls in opposite direction, two consecutive quarter rolls in opposite direction

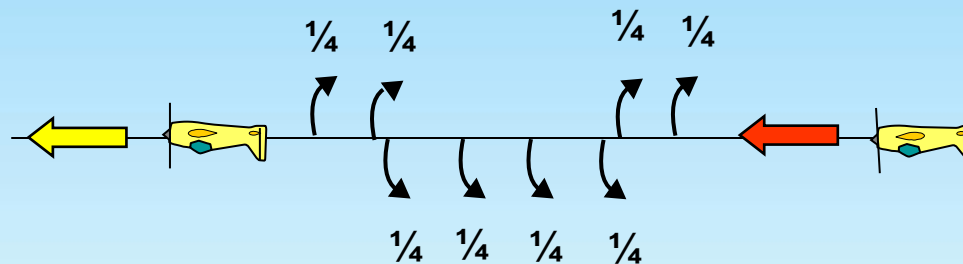

From inverted, perform consecutively two consecutive quarter rolls, four consecutive quarter rolls in opposite direction, two consecutive quarter rolls in opposite direction, exit inverted.





F-25.03 Roll Combination with consecutive two quarter rolls, four consecutive quarter rolls in opposite direction, two consecutive quarter rolls in opposite direction

Lines between part rolls must be short and of equal length.

Between part rolls in opposite direction there must be no line.

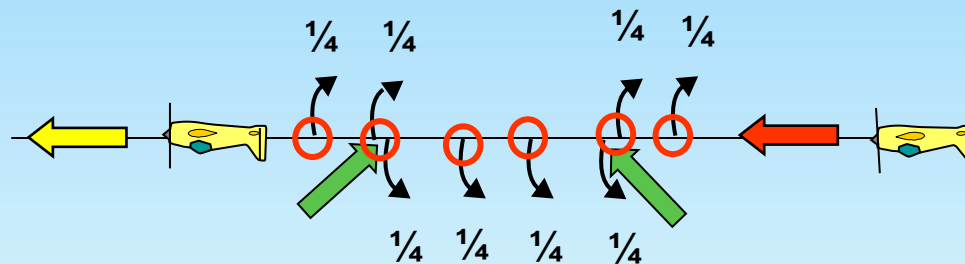

F-25.04 Half Loop with half roll integrated

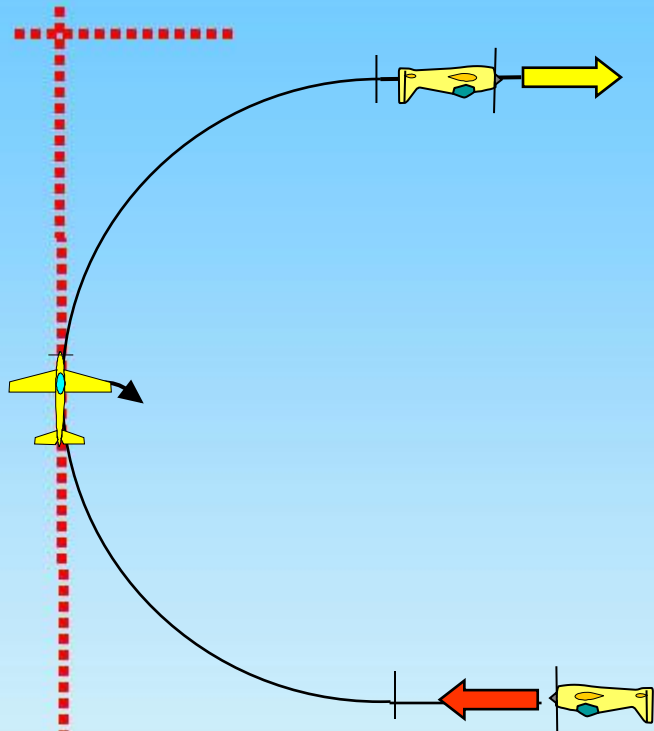

From inverted, push through a half loop while integrating a half roll, exit inverted..

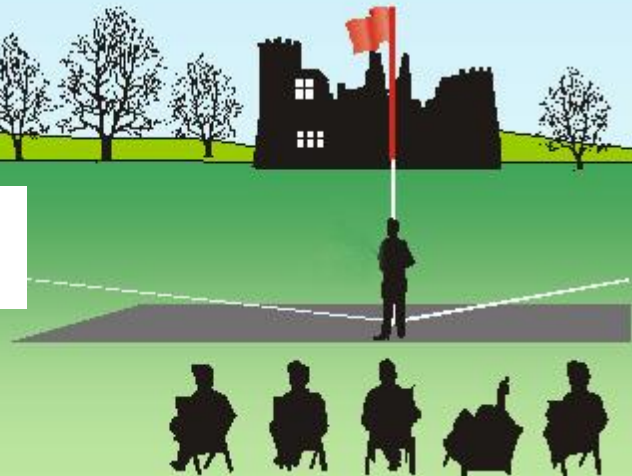



F-25.04 Half Loop with half roll integrated

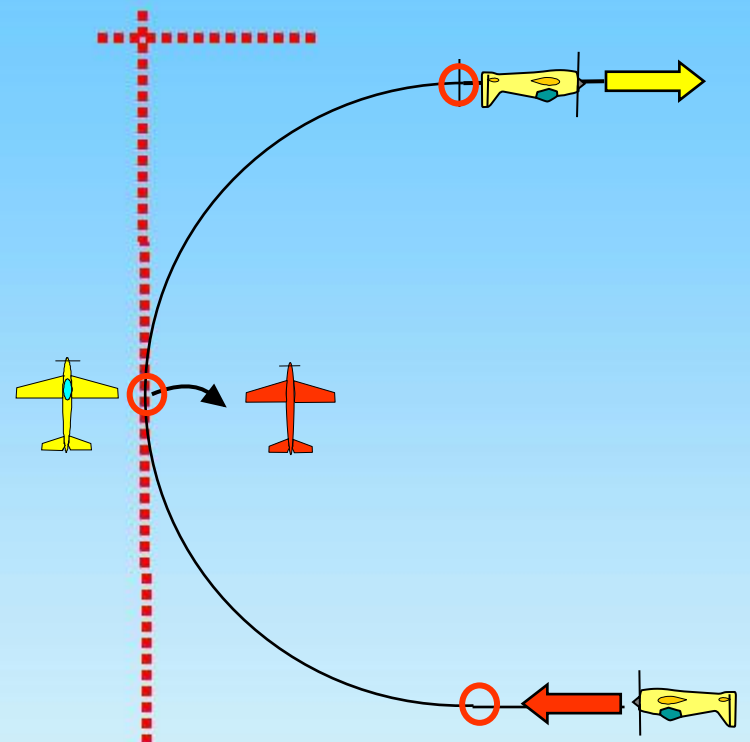

Roll rate must be constant.

$\frac{1}{2}$ roll must be integrated on circular flightpath of the half loop.





F-25.05 Pull Pull Push Humpty Bump with one and half snap roll, half roll integrated, one and a half roll.

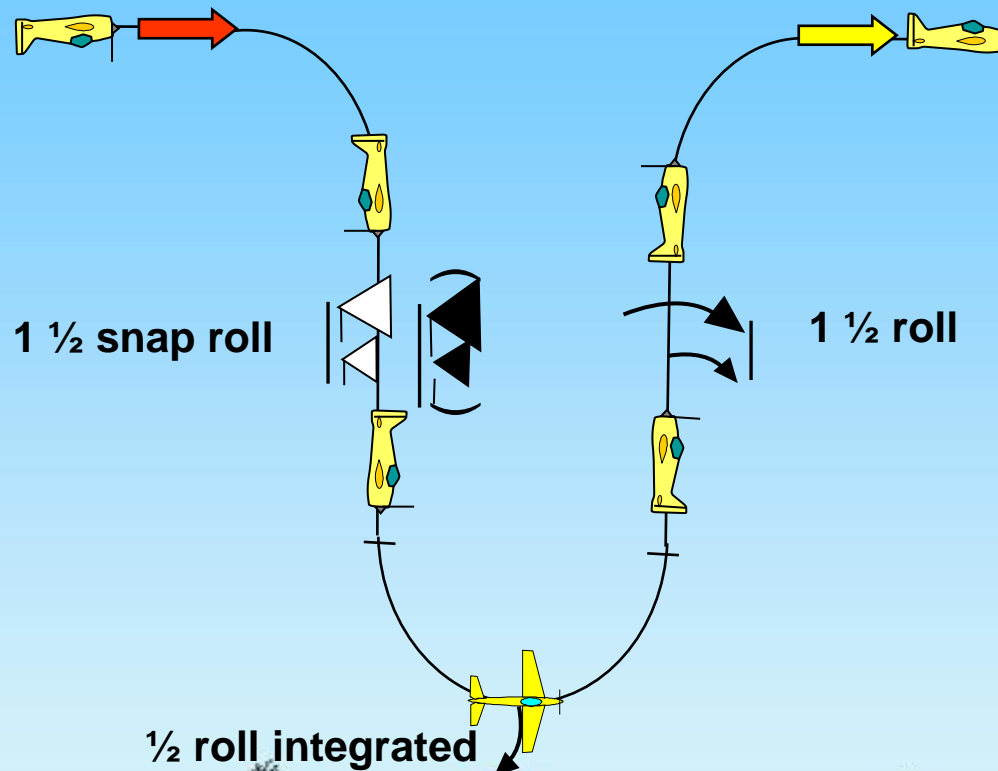

From inverted, before centre pull through a quarter loop into a vertical downline, perform one and a half snap roll, pull through a half loop with half roll integrated into a vertical upline, perform one and a half continuous roll, push through a quarter loop, exit upright.





F-25.05 Pull Pull Push Humpty Bump with one and half snap roll, half roll integrated, one and a half roll.

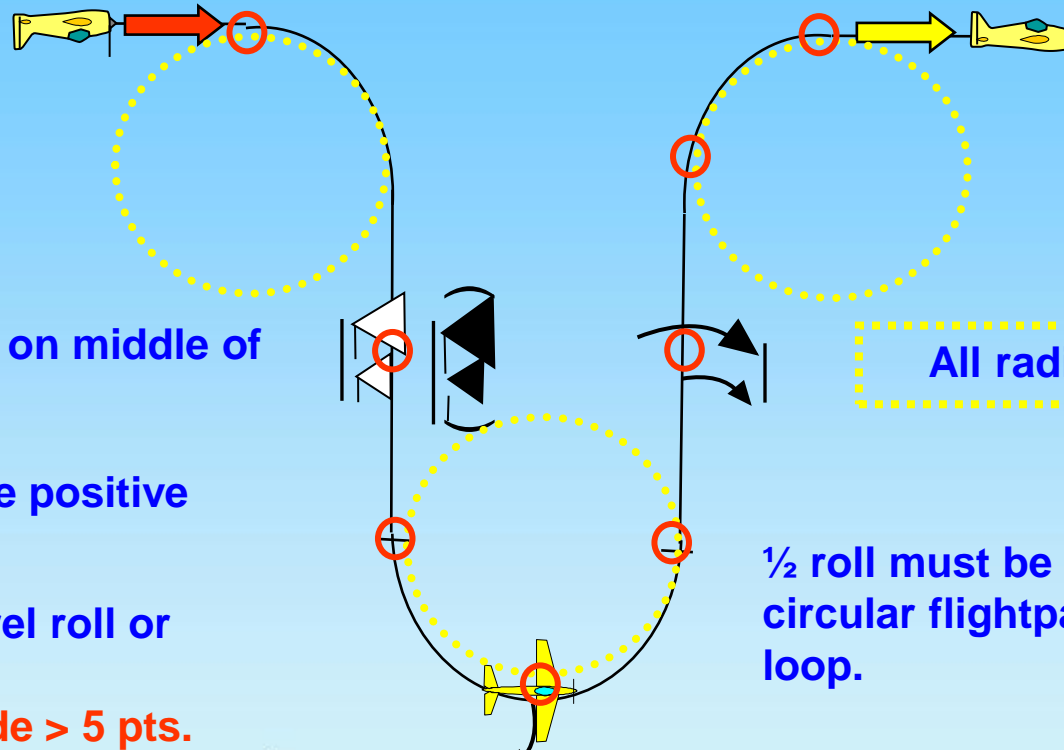

Snap roll and roll on middle of the line.

Snap rolls may be positive or negative.

If snap roll = barrel roll or aileron roll:
Severe downgrade > 5 pts.

All radii are equal.

$\frac{1}{2}$ roll must be integrated on circular flightpath of the half loop.





F-25.06 Three Turn Spin with half roll

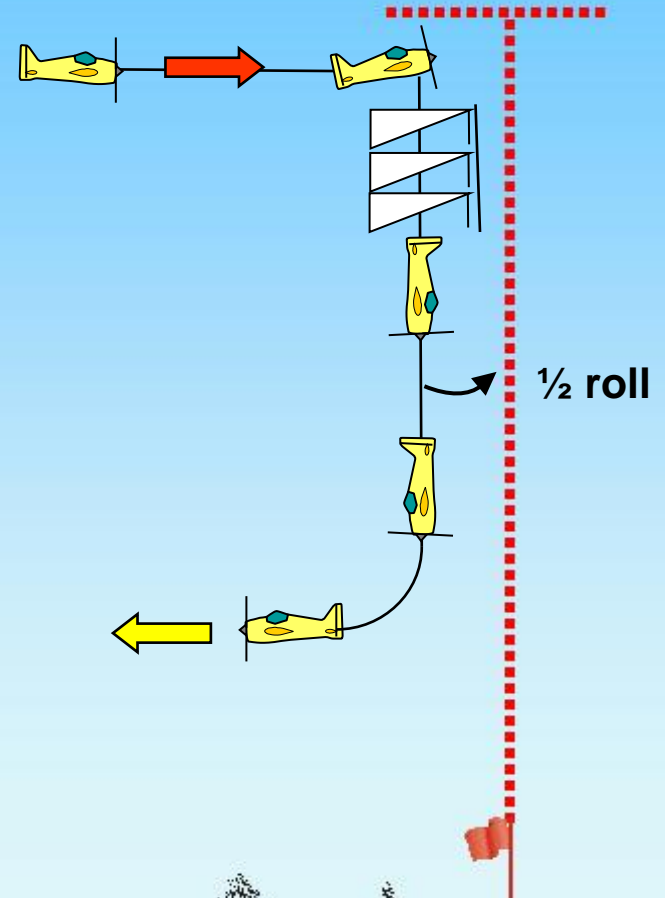

From upright, perform a spin with three turns, perform a vertical downline, perform a half roll, pull through a quarter loop, exit upright.



F-25.06 Three Turn Spin with half roll

Snap entry - 0 points!

Spiral dive - 0 points!

Forced entry: downgrade.

Line after the spins.

Half roll on middle of the line.

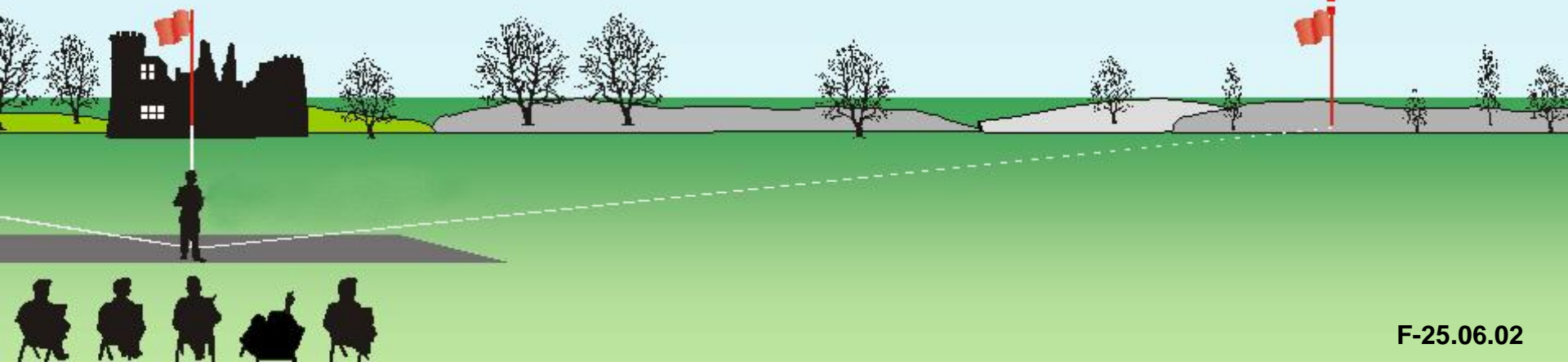
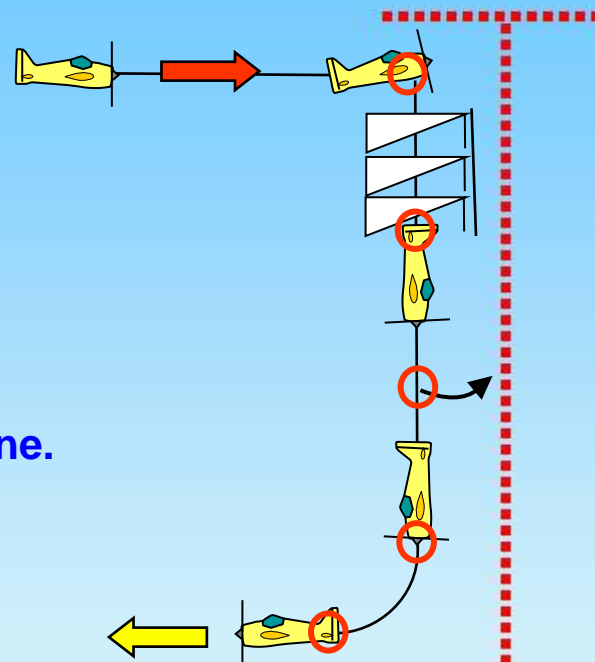



F-25.07 Horizontal Circle with three half rolls in opposite direction integrated

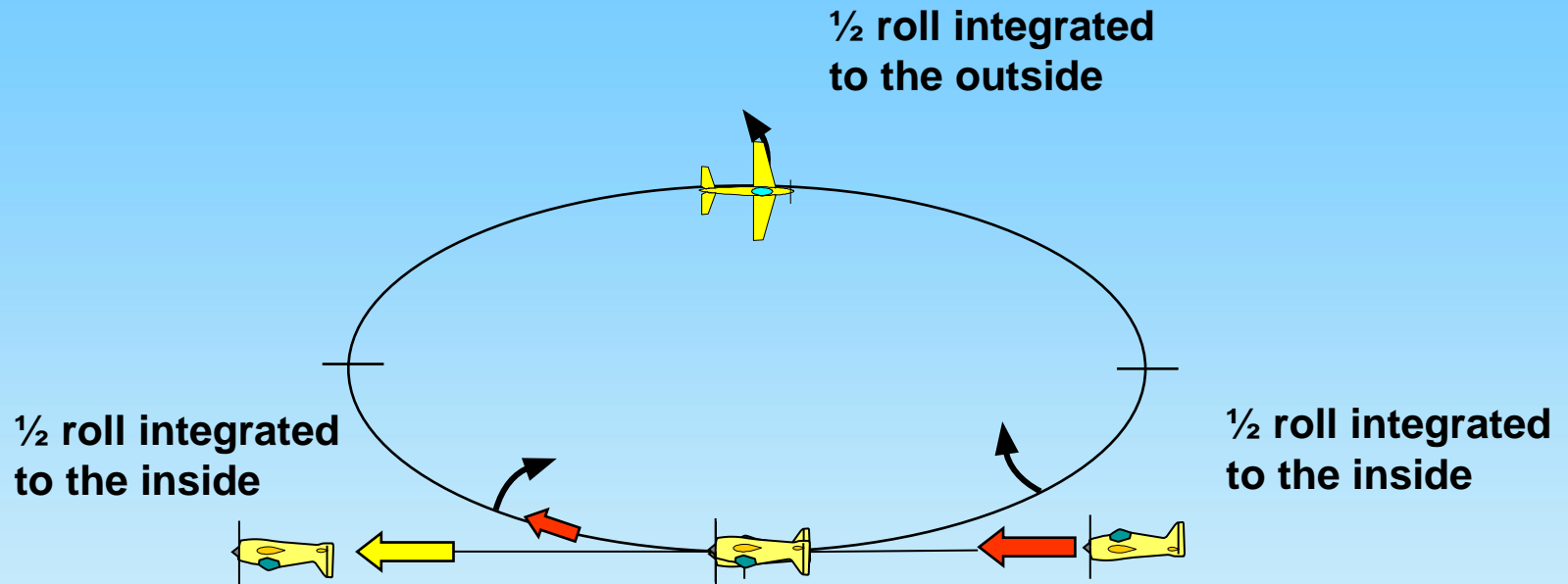

$\frac{1}{2}$ roll



From upright, perform a horizontal circle with half roll integrated in the first ninety degrees, half roll in opposite direction integrated in next one hundred eighty degrees, half roll in opposite direction integrated in the last ninety degrees, exit inverted.

Note: First half roll is to the inside.





F-25.07 Horizontal Circle with three half rolls in opposite direction integrated

Roll reversal must be immediate.

plane in knife-edge

Circle must be of constant radius and must be flown at the same altitude.

Roll rates must be constant.

plane inverted

plane upright

First $\frac{1}{2}$ roll integrated must be inside.

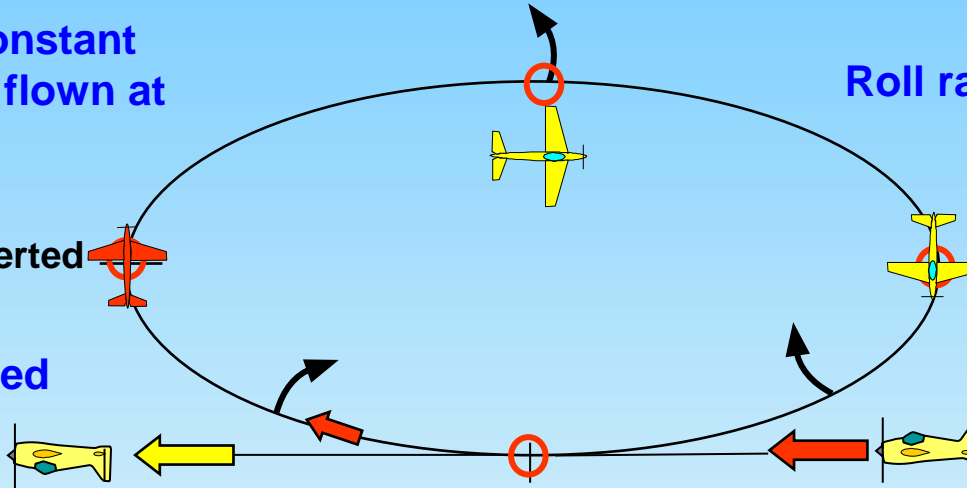

The $\frac{1}{2}$ rolls must be integrated on circular flightpath.





F-25.08 Shark Fin with roll, two snap rolls in opposite direction

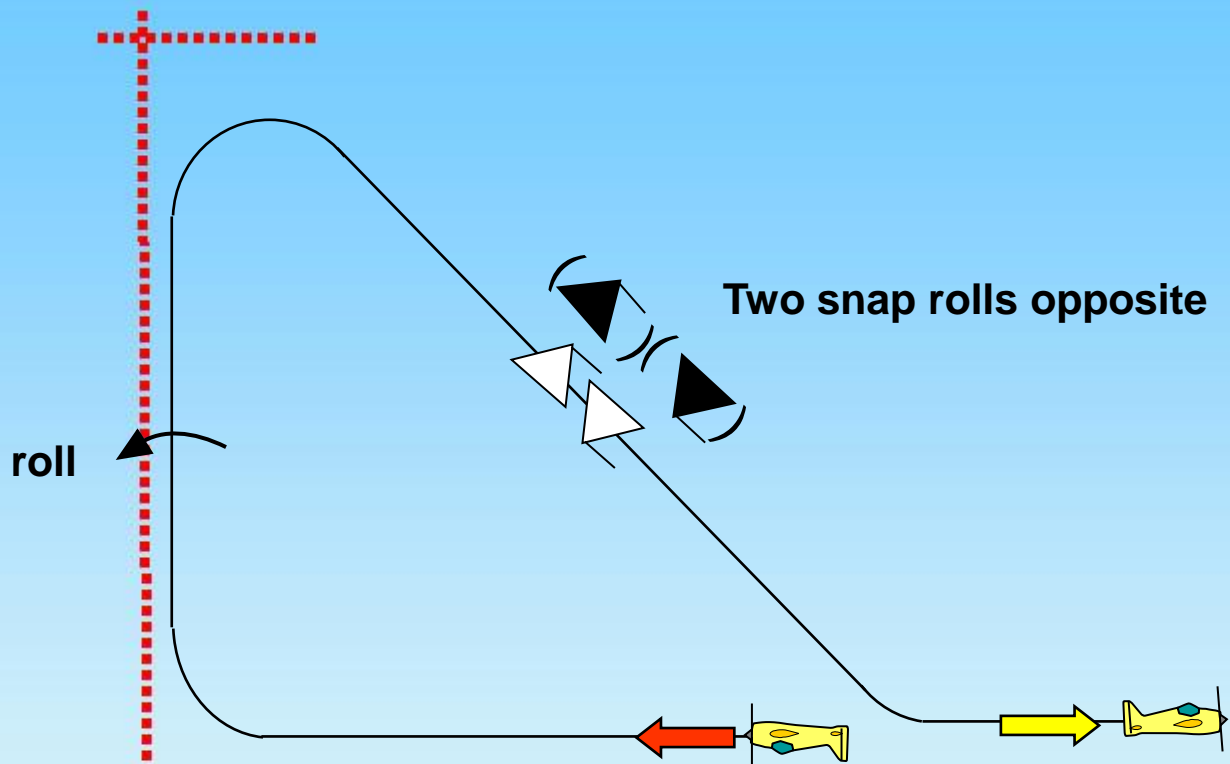

From inverted, push trough a quarter loop into a vertical upline, perform a roll, push through a three eighths loop into a forty-five degree downline, perform consecutively two snap rolls in opposite direction, pull through a one eighth loop, exit upright.





F-25.08 Shark Fin with roll, two snap rolls in opposite direction

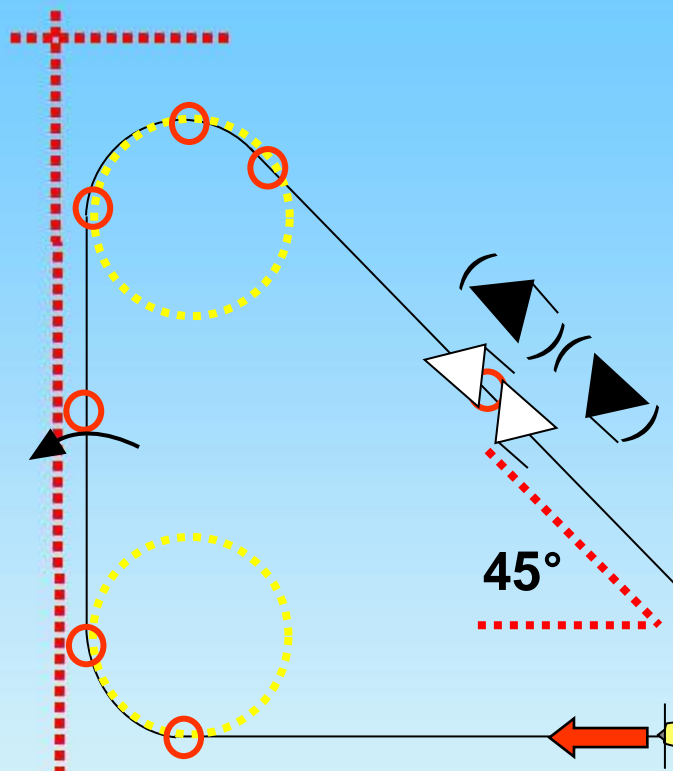

Roll and Snap rolls on middle of the line.

Snap rolls may be positive or negative.

Between snap rolls in opposite direction there must be no line.

If snap roll = barrel roll or aileron roll:
Severe downgrade > 5 pts.

All radii are equal.

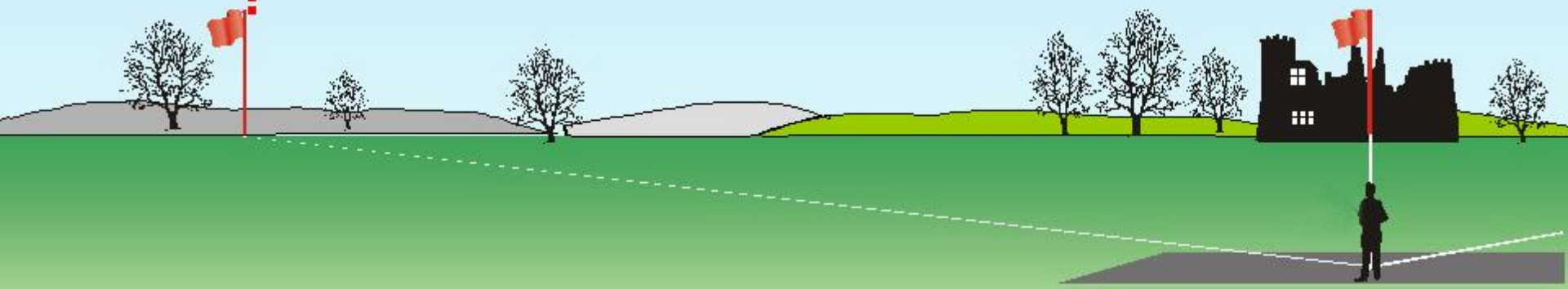



F-25.09 Square Vertical Eight with half roll, roll, quarter roll, roll, quarter roll, roll, half roll

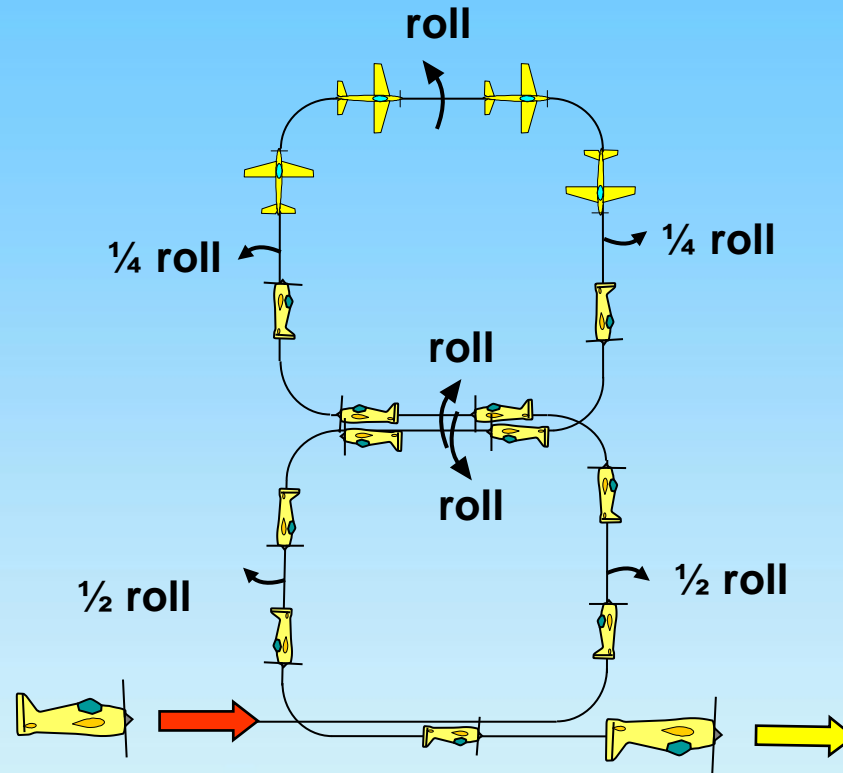

From upright, pull through a quarter loop into a vertical upline perform a half roll, push through a quarter loop, perform a roll, pull through a quarter loop into a vertical upline perform a quarter roll, perform a quarter knife edge loop (towards the center), perform a roll, perform a quarter knife-edge loop into a vertical downline, perform a quarter roll, push through a quarter loop, perform a roll, pull through a quarter loop into a vertical downline, perform a half roll, push through a quarter loop, exit inverted.



F-25.09 Square Vertical Eight with half roll, roll, quarter roll, roll, quarter roll, roll, half roll



All rolls on middle of the lines.

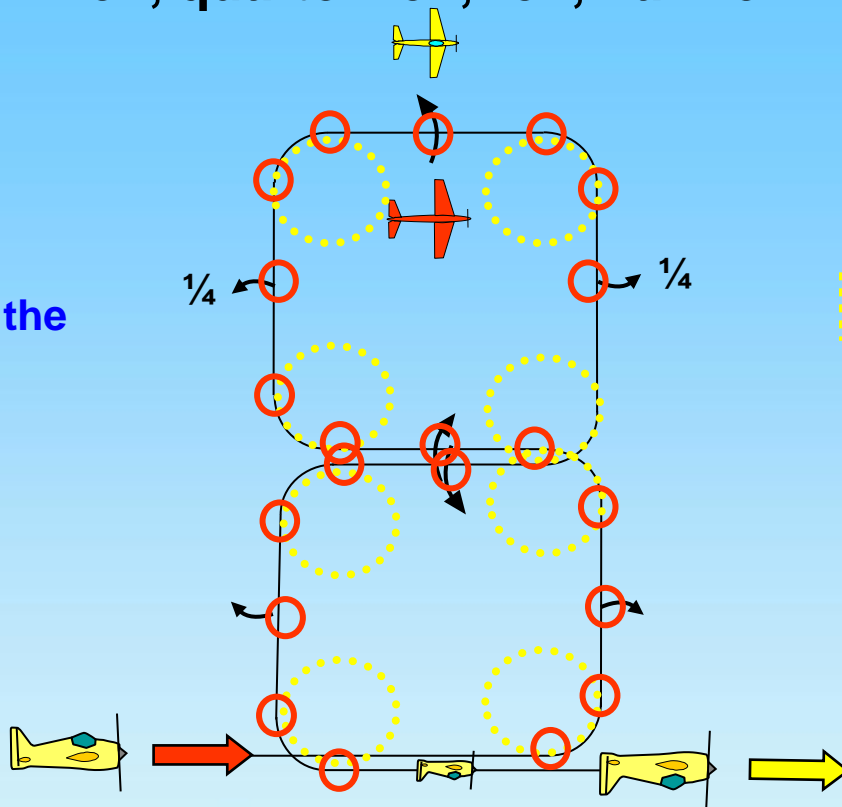

All radii are equal.

Entry and exit must be at the same altitude.





F-25.10 Push Push Pull Humpty Bump with half roll, one and a half roll.

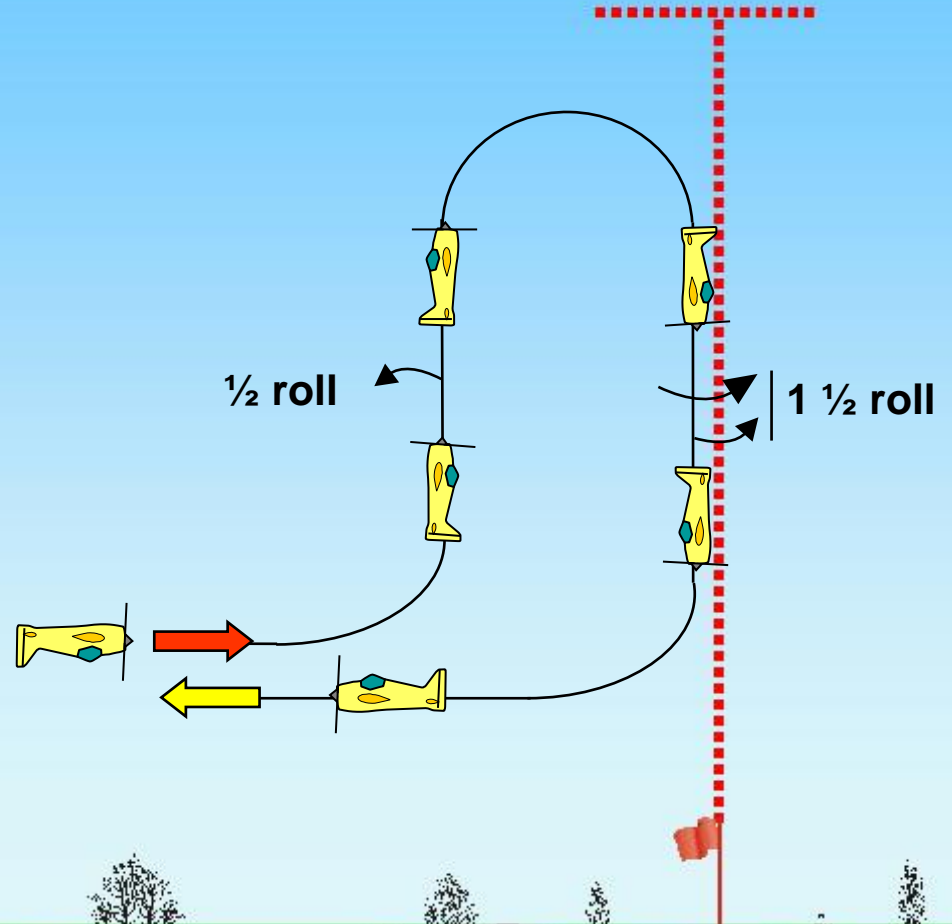

From inverted, push through quarter loop into a vertical upline, perform a half roll, push through a half loop into a vertical downline, perform one and a half continuous rolls, pull through quarter loop, exit upright.



F-25.10 Push Push Pull Humpty Bump with half roll, one and a half roll.

Rolls on middle of the line.

All radii are equal.

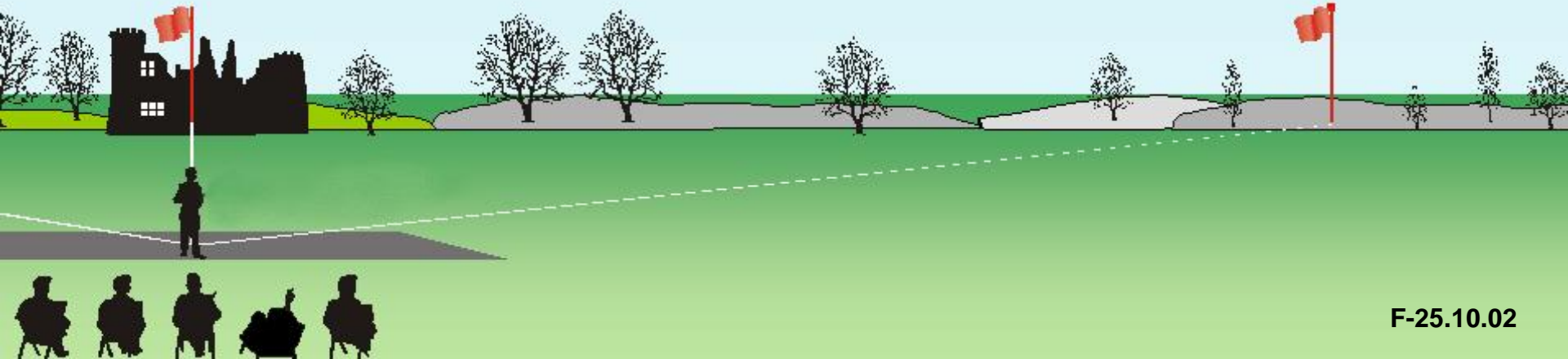
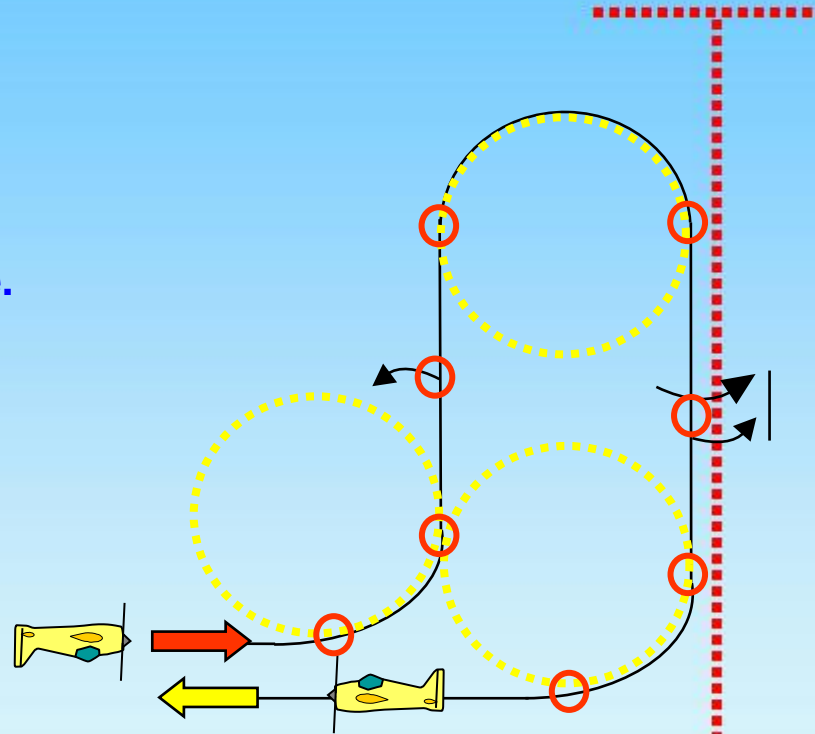



F-25.11 Knife-Edge Triangle with quarter roll integrated, half roll, half roll integrated, half roll, quarter roll integrated

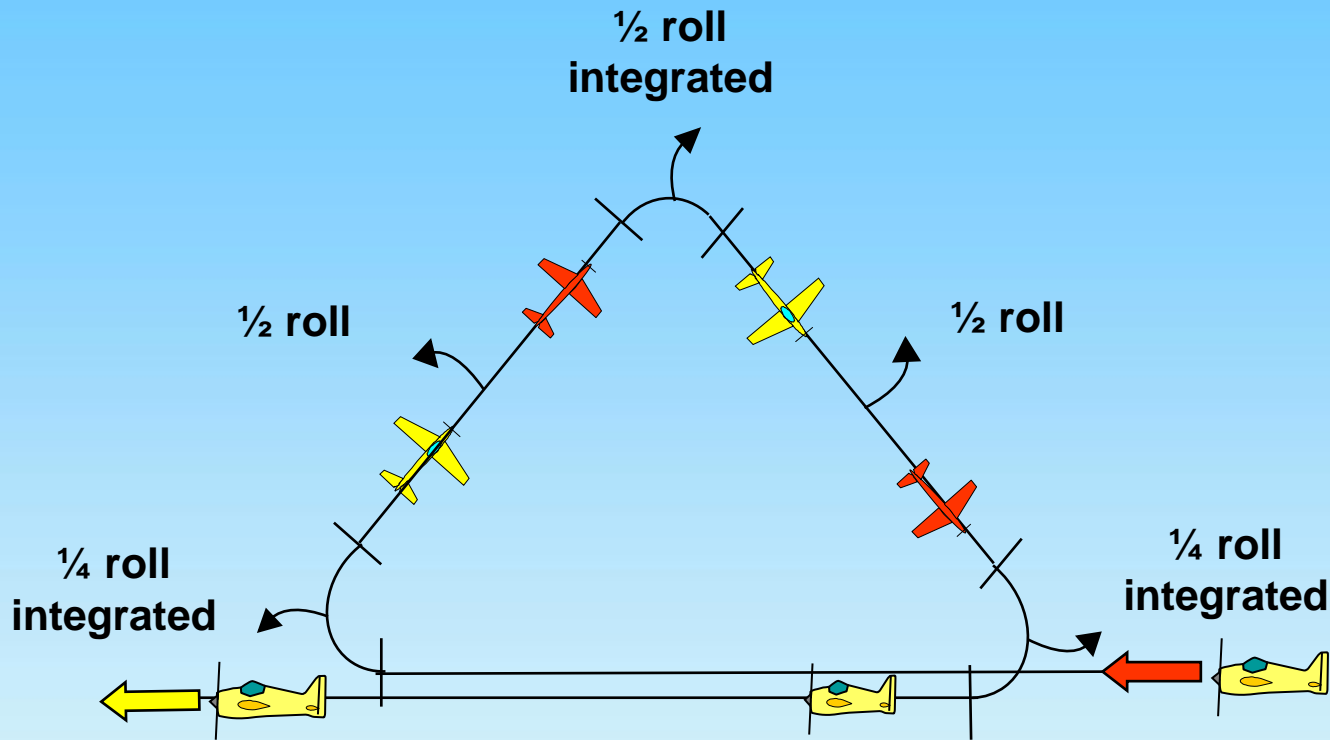

From upright, fly past center pull through a three eighths loop with quarter roll integrated into a forty-five degree knife-edge upline, perform a half roll, perform a quarter knife-edge loop with a half roll integrated into a forty-five degree knife-edge downline, perform a half roll, perform a three eighths knife-edge loop with a quarter roll integrated, exit upright.

F-25.11 Knife-Edge Triangle with quarter roll integrated, half roll, half roll integrated, half roll, quarter roll integrated



1/2 rolls on middle of the line.

Part rolls integrated on circular flightpath of the part loops.

During Knife Edge the wing must be in the vertical plane.

All radii are equal.

1/4 roll integrated

1/2 roll integrated

1/4 roll integrated

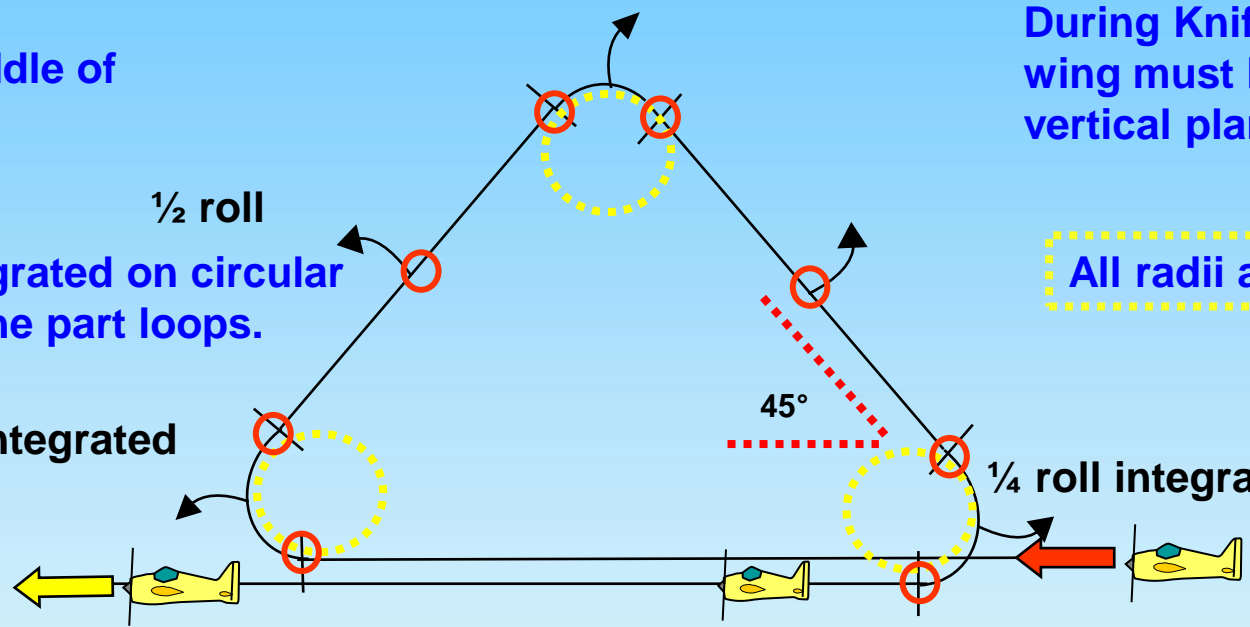

F-25.12 Half Eight Sided Loop with quarter roll, quarter roll

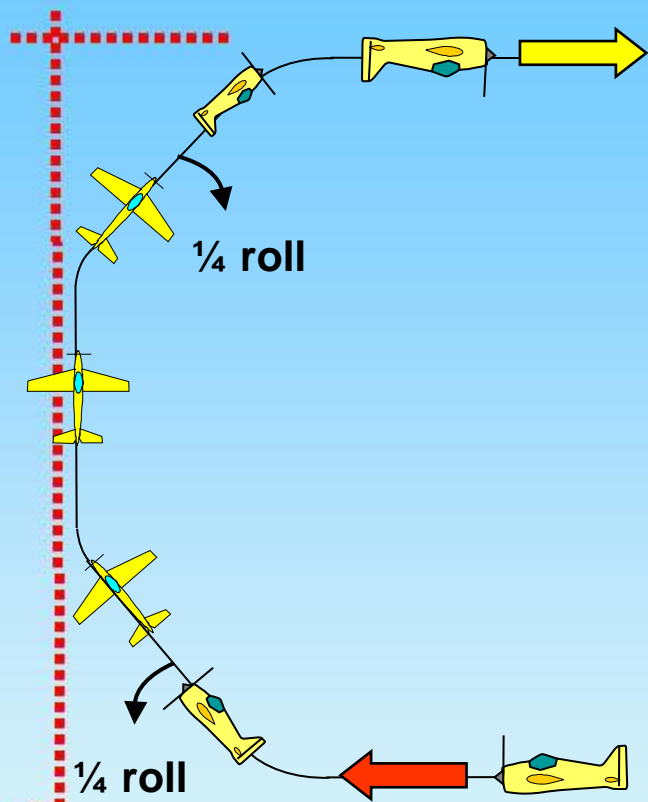

From upright, pull through a one eighth loop into a forty-five degree upline, perform a quarter roll, perform a one eighth knife-edge loop into a vertical upline, perform a one eighth knife-edge loop into a forty-five degree knife-edge upline, perform a quarter roll, pull through a one eighth loop, exit inverted.

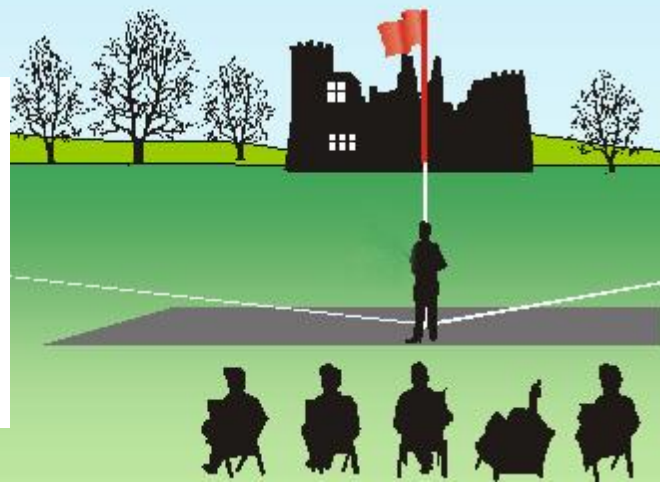



F-25.13 Forty Five Degree Downline with two consecutive one and a quarter rolls in opposite direction.

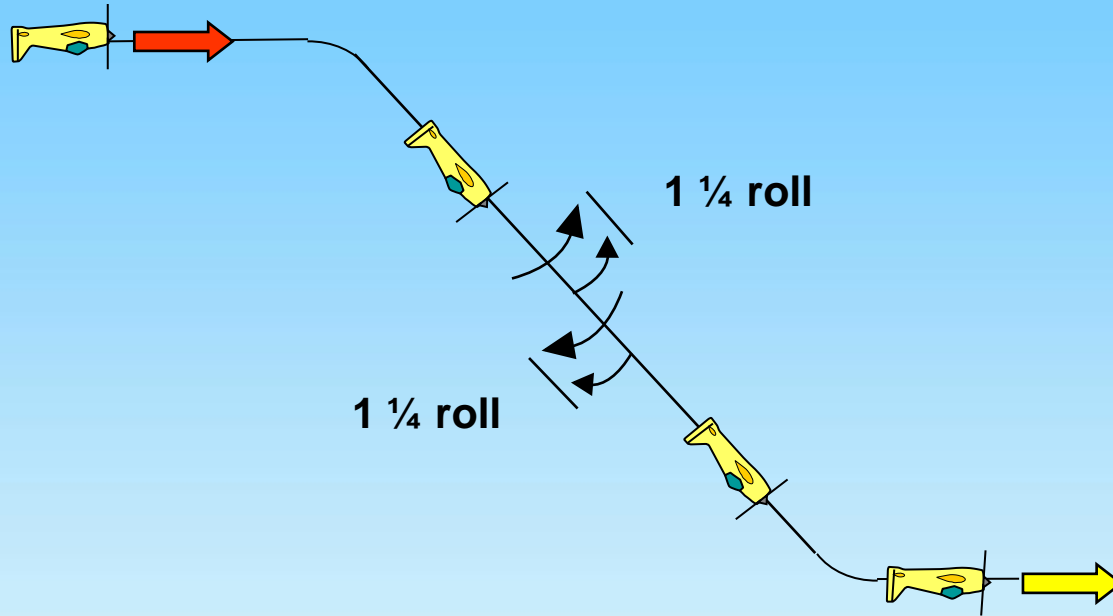

From inverted, pull through a one eighth loop into a forty five degree downline, perform consecutively two one and a quarter rolls in opposite direction, push through a one eighth loop, exit inverted.





F-25.13 Forty Five Degree Downline with two consecutive one and a quarter rolls in opposite direction.

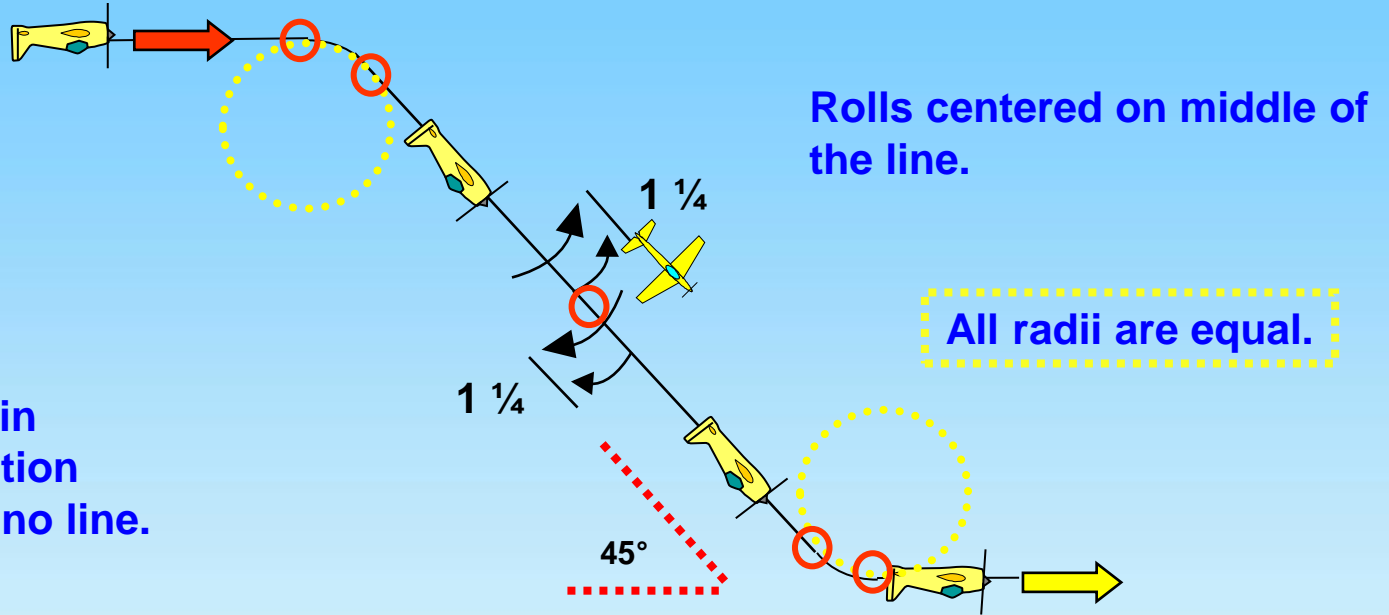

Between rolls in opposite direction there must be no line.





F-25.14 Half Square Loop with roll, half roll in opposite direction

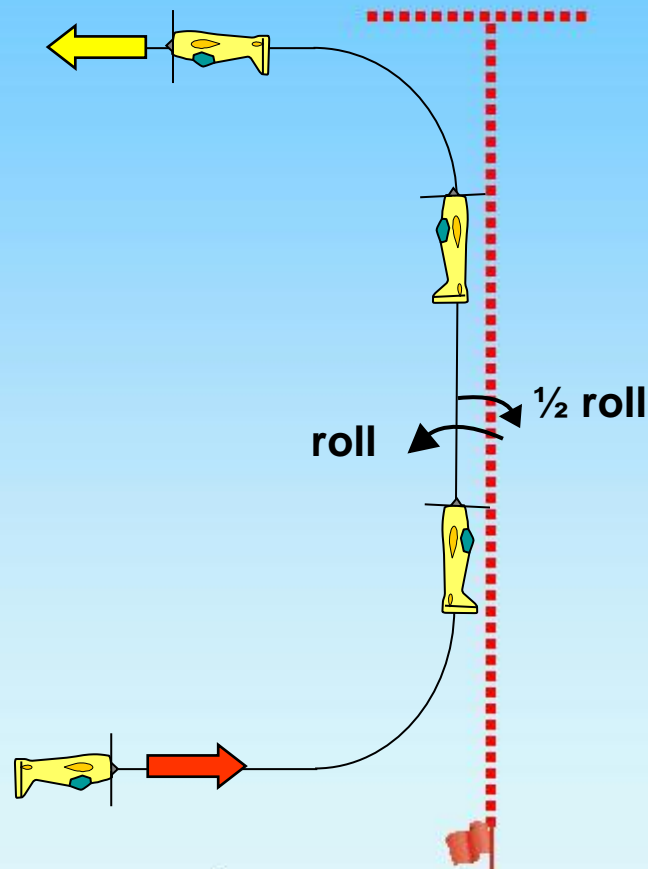

From inverted, push through a quarter loop into a vertical upline, perform consecutively a roll and a half roll in opposite direction, pull through a quarter loop, exit inverted.

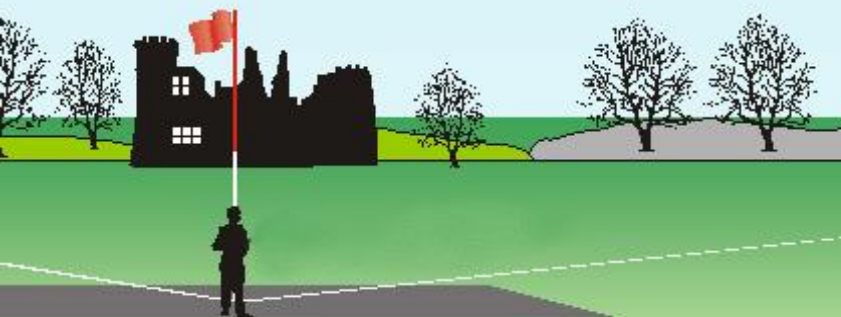



F-25.14 Half Square Loop with roll, half roll in opposite direction

Rolls centered on middle of the line.

Between rolls and part rolls in opposite direction there must be no line.

All radii are equal.

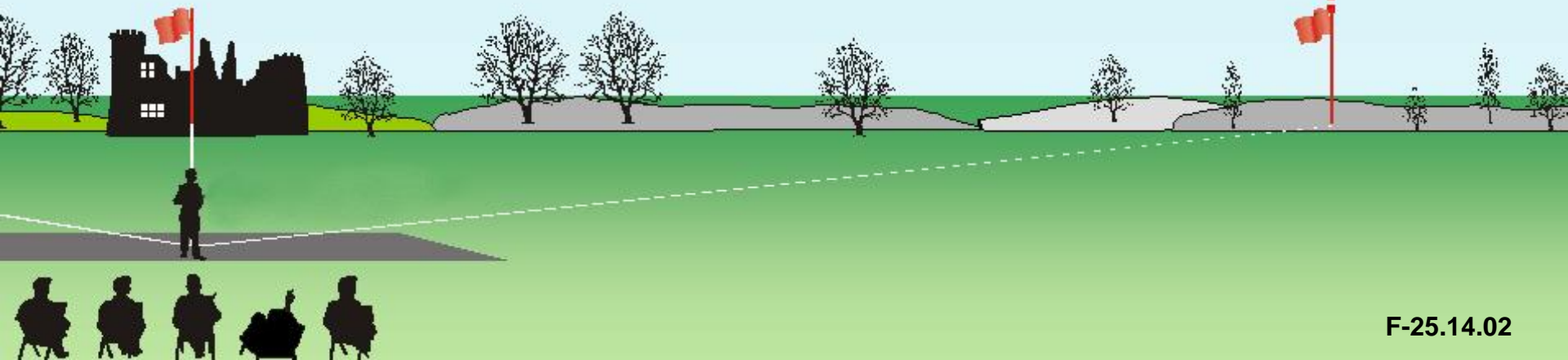
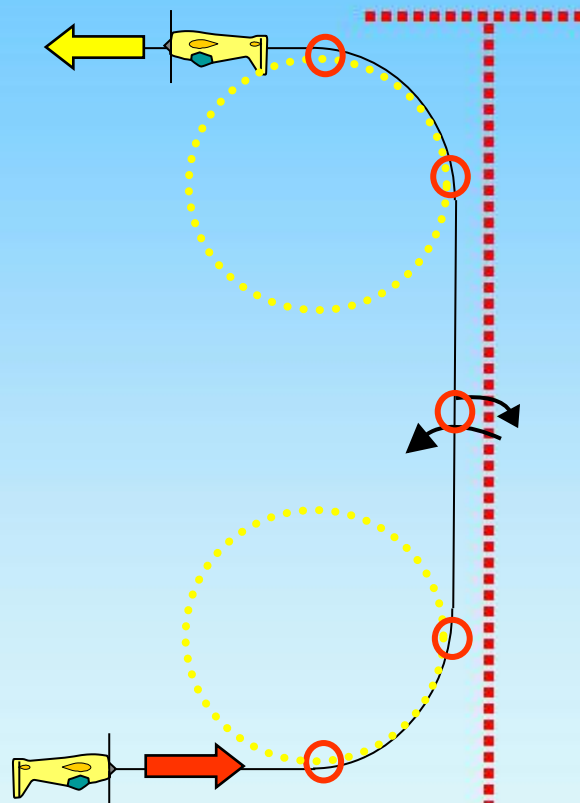



F-25.15 Avalanche (from top) with quarter roll integrated, snap roll, quarter roll integrated

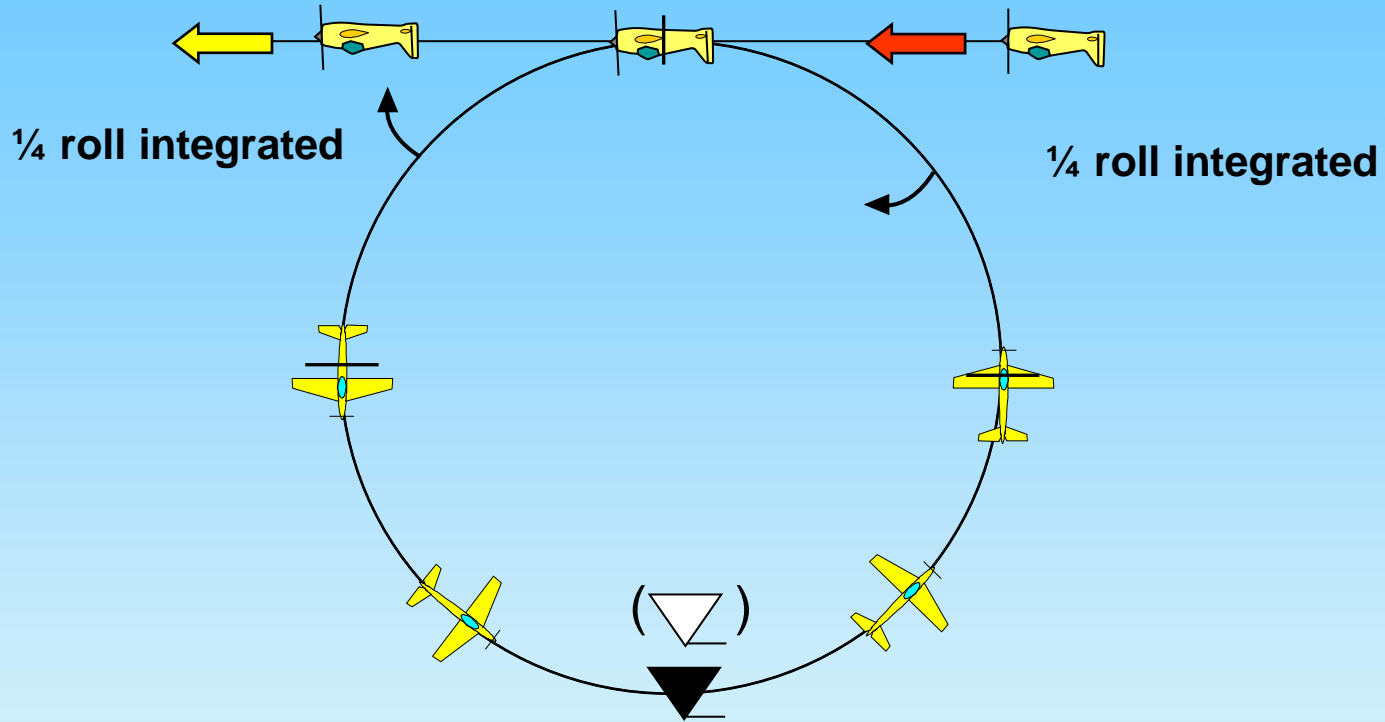

From inverted, pull through a loop, perform a quarter roll integrated in the first ninety degrees of the loop, perform a snap roll at the bottom of the loop, perform a quarter roll integrated in last ninety degrees of the loop, exit inverted.





F-25.15 Avalanche (from top) with quarter roll integrated, snap roll, quarter roll integrated

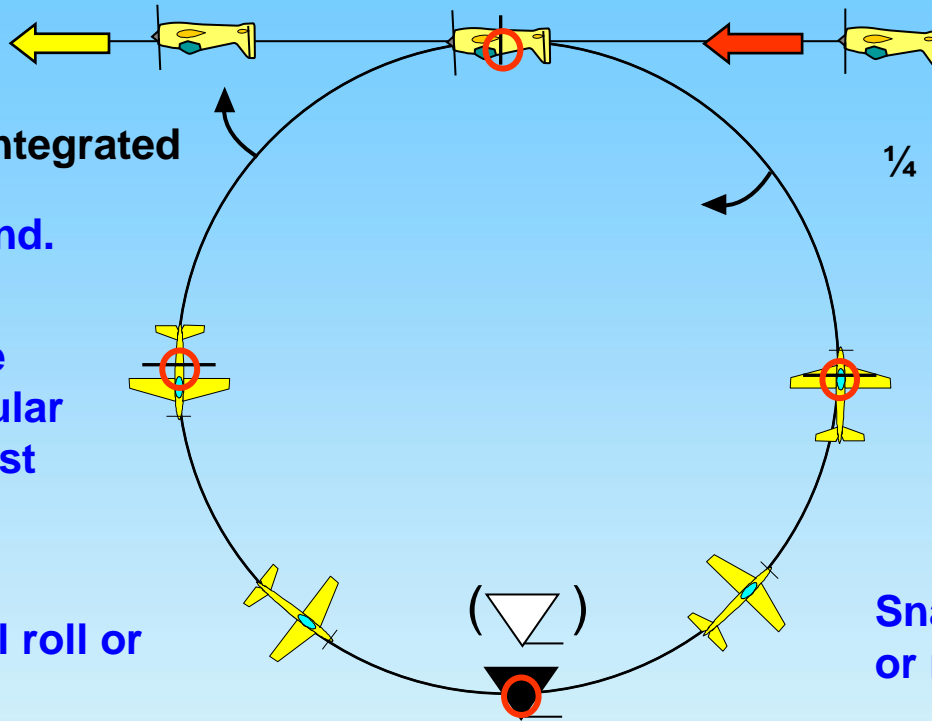

$\frac{1}{4}$ roll integrated

$\frac{1}{4}$ roll integrated

Loop must be round.

The $\frac{1}{4}$ roll must be integrated on circular flightpath of the last 90° of the loop.

The $\frac{1}{4}$ roll must be integrated on circular flightpath of the first 90° of the loop.

If snap roll = barrel roll or aileron roll:
Severe downgrade > 5 pts.

Snap roll may be positive or negative.



F-25.16 Knife-Edge Split S with quarter roll, quarter roll

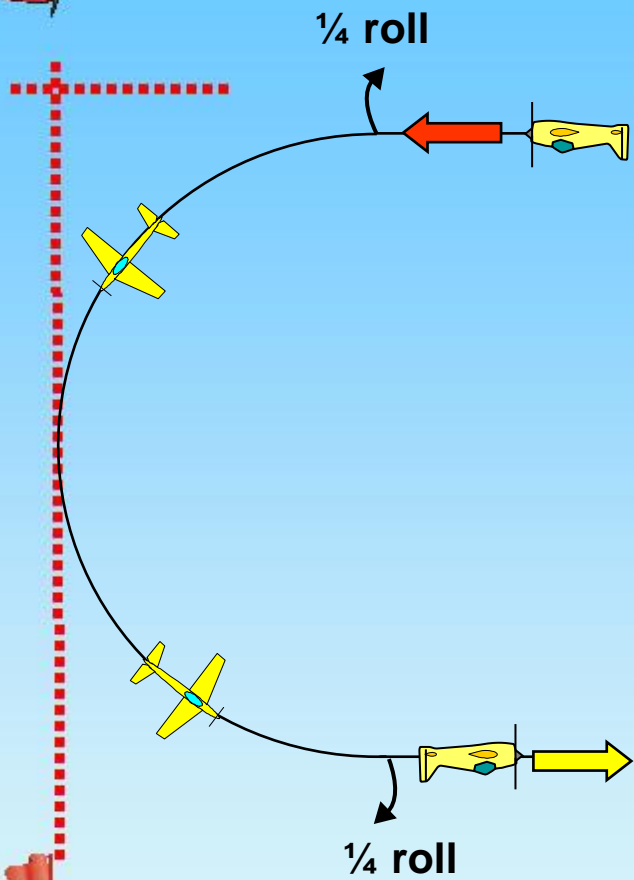

From inverted, perform a quarter roll, immediately perform a half knife-edge loop down, immediately perform a quarter roll, exit inverted.



F-25.16 Knife-Edge Split S with quarter roll, quarter roll

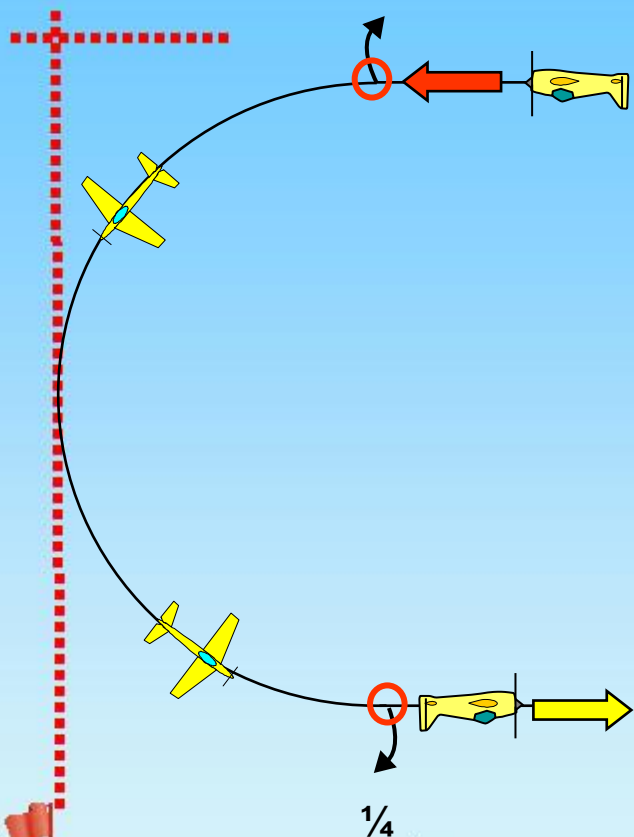

The half knife-edge loop starts immediately after the $\frac{1}{4}$ roll, the second $\frac{1}{4}$ roll starts immediately after the half knife-edge loop.

During knife-edge the wing must be in the vertical plane.

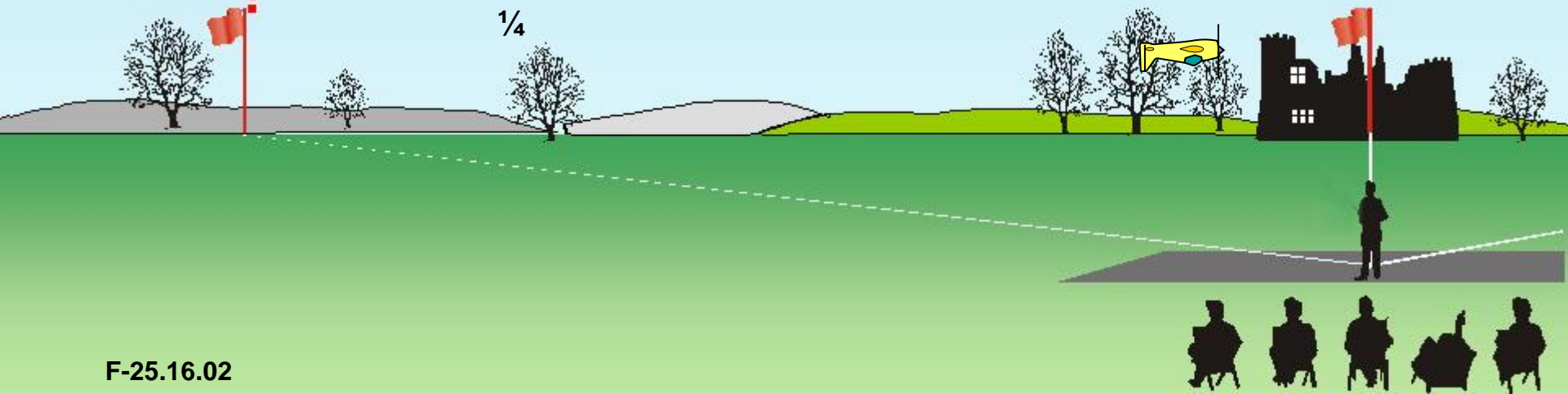



F-25.17 Stall Turn with half roll, three quarter rolls, three quarter snap roll, half roll

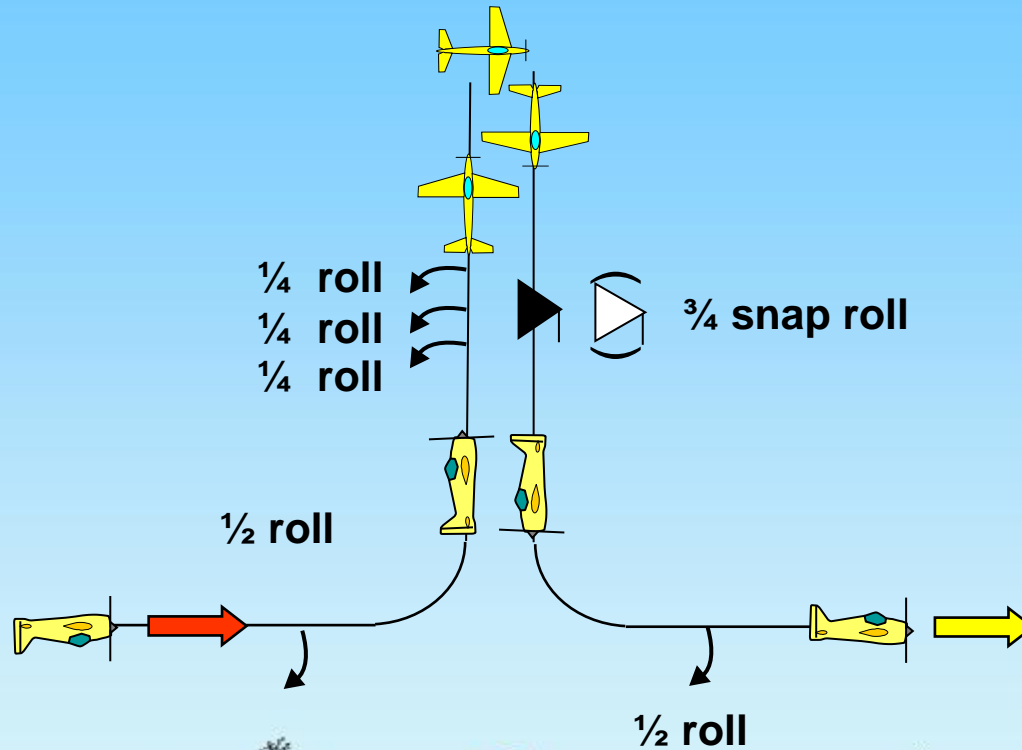

From inverted, perform a half roll, pull through a quarter loop into a vertical upline, perform three consecutive quarter rolls, perform a stall turn into a vertical downline, perform a three quarter snap roll, push through a quarter loop, perform a half roll, exit upright.

Note: Exit starts after the last half roll.





F-25.17 Stall Turn with half roll, three quarter rolls, three quarter snap roll, half roll

Stop before pivot

$\frac{1}{4}$ rolls centered on middle of the line.

Lines between part rolls must be short and of equal length.

Pivot on CG

Two wing spans or more
– zero points!

$\frac{3}{4}$ snap roll on middle of the line.

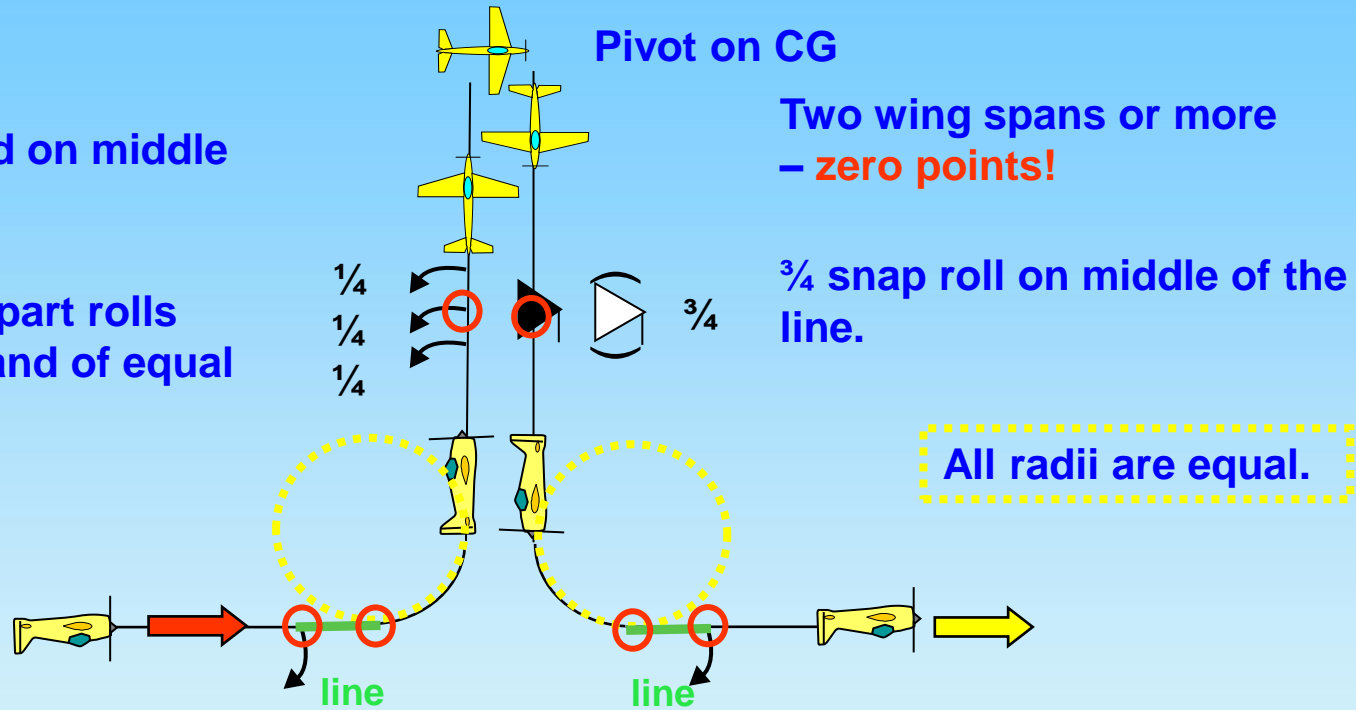

All radii are equal.





Landing procedure (not judged, not scored)

The direction of the landing may be different to the take off.

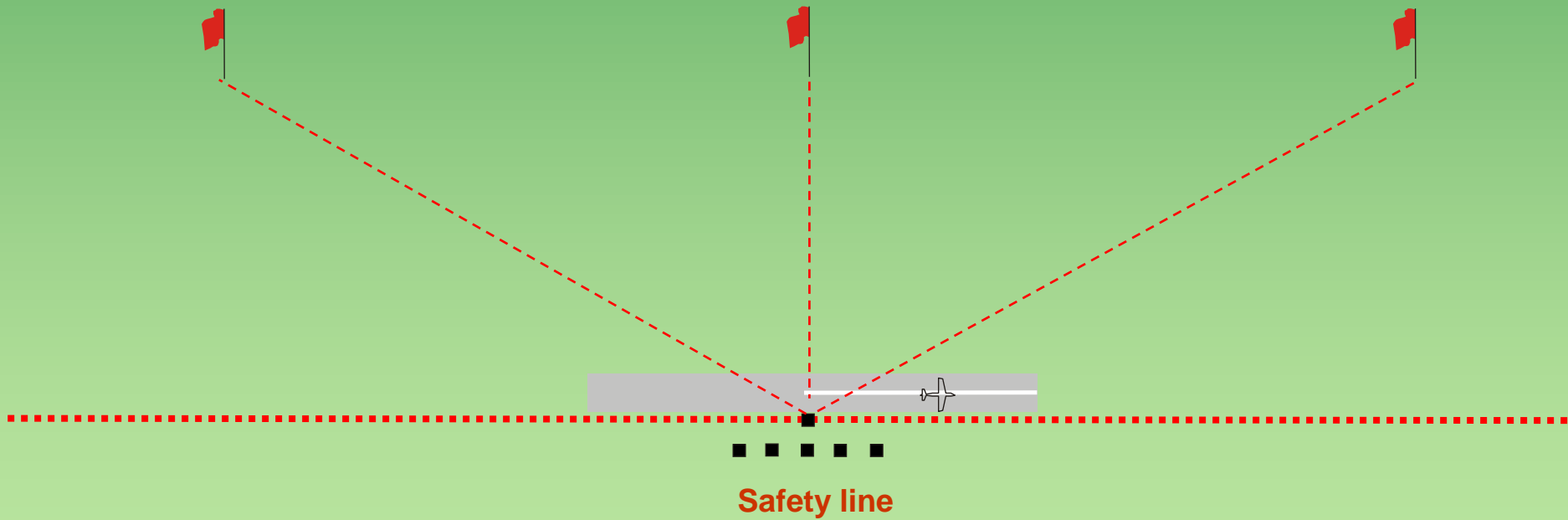

Forget **WHO** is flying
(friend, rival, countryman, flier from other nation)

Forget **WHAT** is flying
(2-stroke, 4-stroke, electric)

LOOK ONLY AT LINES DESCRIBED IN THE SKY!

Bob Skinner

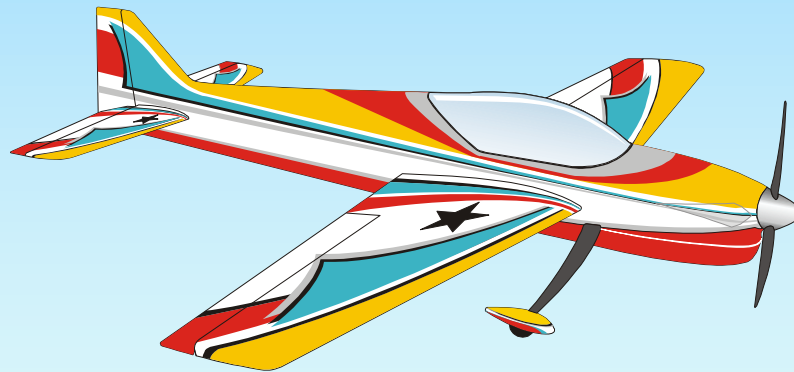

Thank you!

© Peter Uhlig, April 2023